

ACS580-0P with bypass

Supplement Installation Manual for ACS580-0P with bypass

ACS580-0P+F255+G310 Enclosed Drives with Two-Contactor Bypass
(230V, 1-100 HP; 480V, 1-350 HP; 575, 2-150 HP)



ABB

Table of Contents

Safety instructions

- Use of warnings and notes in this manual 4
- General safety in installation, start-up and maintenance 4
- Electrical safety in installation, start-up and maintenance 5
- Additional instructions for permanent magnet motor drives 7
- General safety in operation 8
- Cybersecurity disclaimer 8

Contents

ACS580-0P with Bypass

- Installation 10
- Operation 32
- Dimensions and weights 38

Appendix A - Overload Relays



Safety instructions

These are the safety instructions which you must obey when you install and operate the drive and do maintenance on the drive. If you ignore the safety instructions, injury, death or damage can occur.

Use of warnings and notes in this manual

Warnings tell you about conditions which can cause injury or death, or damage to the equipment. They also tell you how to prevent the danger. Notes draw attention to a particular condition or fact, or give information on a subject.

The manual uses these warning symbols:

	Electricity warning tells about hazards from electricity which can cause injury or death, or damage to the equipment.
	General warning tells about conditions, other than those caused by electricity, which can cause injury or death, or damage to the equipment.
	Electrostatic sensitive devices warning tells you about the risk of electrostatic discharge which can cause damage to the equipment.

General safety in installation, start-up and maintenance

These instructions are for all personnel that install the drive and do maintenance work on it.

 **WARNING!** Obey these instructions. If you ignore them, injury or death, or damage to the equipment can occur.

- Use safety shoes with a metal toe cap to avoid foot injury. Wear protective gloves and long sleeves. Some parts have sharp edges.
- Warning! Handle and ship floor-standing enclosures only in the upright position.

These units are not designed to be laid on their backs.

- Use a pallet truck to move the package/ enclosure to the installation site.
- Remove any bolts that secure the cabinet to the shipping pallet.
- Use the lifting lugs/bars at the top of the unit to lift floor-standing enclosures.
- Use a hoist to lift the enclosure. (Do not place enclosure in final position until mounting site is prepared.)



- Beware of hot surfaces. Some parts, such as heatsinks of power semiconductors, remain hot for a while after disconnection of the electrical supply.
- Keep the drive in its package or protect it otherwise from dust and burr from drilling and grinding until you install it.
- Vacuum clean the area below the drive before the start-up to prevent the drive cooling fan from drawing the dust inside the drive.

- Do not cover the air inlet and outlet when the drive runs.
 - Make sure that there is sufficient cooling. See the *ACS580 Hardware Manual (3AXD50000044794)* and *Quick Start Guide (3AXD50000049129)* for more information.
 - Before you connect voltage to the drive, make sure that the doors are closed. Keep the doors closed during the operation.
 - Before you adjust the drive operation limits, make sure that the motor and all driven equipment can operate throughout the set operation limits.
 - Before you activate the automatic fault reset or automatic restart functions of the drive control program, make sure that no dangerous situations can occur. These functions reset the drive automatically and continue safe operation after a fault or supply break. If these functions are activated, the installation must be clearly marked as defined in IEC/EN 61800-5-1, subclause 6.5.3, for example, "THIS MACHINE STARTS AUTOMATICALLY".
 - The maximum number of drive power-ups is five in ten minutes. Too frequent power-ups can damage the charging circuit of the DC capacitors.
 - If you have connected safety circuits to the drive (for example, emergency stop and Safe torque off), validate them at the start up in Drive and Bypass mode. For the validation of the Safe Torque Off, see *ACS580 firmware manual (3AXD50000016097 [English])*. For the validation of other safety circuits, see the instructions provided with them.
- **Warning!** The bypass circuit is not integrated into the drive safe torque off circuit. If safe torque off is employed, it is the user's responsibility to make sure torque is removed from the motor while in bypass mode.
- If you select an external source for start command and it is on, and the start command is level-triggered, the drive will start immediately after fault reset. See parameters 20.02 Ext1 start trigger type and 20.07 Ext2 start trigger type in [ACS580 control program firmware manual \(3AXD50000016097 \[English\]\)](#).
 - When the control location is not set to Local (text Hand is not shown on the top row of the panel and parameter 19.19 Off mode disable has value Off button disabled), the stop key on the control panel will not stop the drive.
 - Frames R1...R5: Do not attempt to repair a malfunctioning drive; contact your local representative for replacement or repair by authorized persons.
 - Frames R6...R9: Can be repaired by authorized persons.

Electrical safety in installation, start-up and maintenance

Precautions before electrical work

These warnings are for all personnel who do work on the drive, motor cable or motor.



WARNING! Frames R1 ... R9: Obey these instructions. If you ignore them, injury or death, or damage to the equipment can occur. If you are not a qualified electrical professional, do not do electrical installation or maintenance work. Go through these steps before you begin any installation or maintenance work.

1. Clearly identify the work location.
2. Disconnect all possible voltage sources. Lock and tag.
 - Open the main disconnect at the power supply of the drive.
 - Make sure that reconnection is not possible.
 - Disconnect any external power sources from the control circuits

Note:

- After you disconnect the drive, always wait for 5 minutes to let the intermediate circuit capacitors discharge before you continue.
3. Protect any other energized parts in the work location against contact.
 4. Take special precautions when close to bare conductors.
 5. Measure that the installation is de-energized.
 - Use a multimeter with an impedance of at least 1 Mohm.
 - Make sure that the voltage between the drive input power terminals (L1, L2, L3) and the grounding terminal (PE) is close to 0 V.

Frames R1...R3: Measure the voltage between the drive UDC+ terminal and grounding terminal (PE) with one multimeter. As there is no UDC- terminal, measure the voltage between the drive T1/U terminal and grounding terminal (PE) with another multimeter. Make sure that the voltage difference between the multimeters is close to 0 V.

Frames R4...R9: Measure the voltage between the drive DC terminals (UDC+ and UDC-) and the grounding terminal (PE) and make sure that it is close to 0 V.

6. Install temporary grounding as required by the local regulations.
7. Ask for a permit to work from the person in control of the electrical installation work.

If the drive does not operate according to these steps, refer to the [ACS580-01 Hardware Manual \(3AXD50000044794\)](#) and [Quick Start Guide \(3AXD50000049129\)](#).

Additional instructions and notes

 **WARNING!** Obey these instructions. If you ignore them, injury or death, or damage to the equipment can occur.

- If the drive will be connected on an IT system (ungrounded or high-resistance-grounded [over 30 ohms]), make sure neither the EMC filter nor the ground-to-phase varistor are connected (metal screws should not be installed). Connections with metal screws in these systems can cause danger or damage. See section *in ACS580 Hardware Manual*.

Note: For other systems, connecting the internal EMC filter will reduce the conducted emission.

- If the drive will be connected on a corner-grounded TN system, make sure the EMC filter is not connected (metal screws should not be installed). Connections with metal screws in these systems can cause danger or damage. See section *in ACS580 Hardware Manual*.

Note: For other systems, connecting the internal EMC filter (using metal screws) will reduce the conducted emission.

- Use all ELV (extra low voltage) circuits connected to the drive only within a zone of equipotential bonding, that is, within a zone where all simultaneously accessible conductive parts are electrically connected to prevent hazardous voltages appearing between them. You can accomplish this by a proper factory grounding, that is, make sure that all simultaneously accessible conductive parts are grounded to the protective earth (PE) bus of the building.
- Do not do insulation or voltage withstand tests on the drive or drive modules.

Note:

- The motor cable terminals of the drive are at a dangerous voltage when the input power is on, regardless of whether the motor is running or not.
- The DC and brake resistor terminals (UDC+, UDC-, R+ and R-) are at a dangerous voltage.
- External wiring can supply dangerous voltages to the terminals of relay outputs (RO1, RO2 and RO3).

- The Safe torque off function does not remove the voltage from the main and auxiliary circuits. The function is not effective against deliberate sabotage or misuse.

 **WARNING!** Use a grounding wrist band when you handle the printed circuit boards. Do not touch the boards unnecessarily. The boards contain components sensitive to electrostatic discharge.

Grounding

These instructions are for all personnel who are responsible for the electrical installation, including the grounding of the drive.

 **WARNING!** Obey these instructions. If you ignore them, injury or death, or equipment malfunction can occur, and electromagnetic interference can increase.

- If you are not a qualified electrical professional, do not do grounding work.
- Always ground the drive, the motor and adjoining equipment to the protective earth (PE) bus of the power supply. This is necessary for the personnel safety. Proper grounding also reduces electromagnetic emission and interference.
- In a multiple-drive installation, connect each drive separately to the protective earth (PE) bus of the power supply.
- Make sure that the conductivity of the protective earth (PE) conductors is sufficient. See section *in ACS580 Hardware Manual*. Obey the local regulations.
- Connect the power cable shields to the protective earth (PE) terminals of the drive.
- Standard IEC/EN & UL 61800-5-1 (section 4.3.5.5.2.) requires that as the normal touch current of the drive is higher than 3.5 mA AC or 10 mA DC, you must use a fixed protective earth (PE) connection. In addition,
 - install a second protective earth conductor of the same cross-sectional area as the original protective earthing conductor,

or

- install a protective earth conductor with a cross-section of at least 7 AWG (10 mm²) Cu,

or

- install a device which automatically disconnects the supply if the protective earth conductor breaks.

Additional instructions for permanent magnet motor drives

Safety in installation, start-up and maintenance

These are additional warnings concerning permanent magnet motor drives. The other safety instructions in this chapter are also valid.

 **WARNING!** Obey these instructions. If you ignore them, injury or death and damage to the equipment can occur.

- Do not work on a drive when a rotating permanent magnet motor is connected to it. A rotating permanent magnet motor energizes the drive including its power terminals.

Before installation, start-up and maintenance work on the drive:

- Stop the motor.
- Disconnect the motor from the drive with a safety switch or by other means.
- If you cannot disconnect the motor, make sure that the motor cannot rotate during work. Make sure that no other system, like hydraulic crawling drives, can rotate the motor directly or through any mechanical connection like felt, nip, rope, etc.
- Measure that the installation is de-energized.
 - Use a multimeter with an impedance of at least 1 Mohm.
 - Make sure that the voltage between the drive output terminals (T1/U, T2/V, T3/W) and the grounding (PE) busbar is close to 0 V.

- Make sure that the voltage between the drive input power terminals (L1, L2, L3) and the grounding (PE) busbar is close to 0 V.
- Make sure that the voltage between the drive DC terminals (UDC+, UDC-) and the grounding (PE) terminal is close to 0 V.
- Install temporary grounding to the drive output terminals (T1/U, T2/V, T3/W). Connect the output terminals together as well as to the PE.

Start-up and operation:

- Make sure the motor is not run over the rated speed with dynamic/positive displacement loads.

General safety in operation

These instructions are for all personnel that operate the drive.

 **WARNING!** Obey these instructions. If you ignore them, injury or death, or damage to the equipment can occur.

- Do not control the motor with the line side disconnect at the drive power supply; instead, use the control panel start and stop keys or commands through the I/O terminals of the drive.
- Give a stop command to the drive before you reset a fault. If you have an external source for the start command and the start is on, the drive will start immediately after the fault reset, unless you configure the drive for pulse start. See the firmware manual.
- Before you activate automatic fault reset functions of the drive control program, make sure that no dangerous situations can occur. These functions reset the drive automatically and continue operation after a fault.

Note: When the drive is not in the Hand mode, the Off key on the control panel will not stop the drive.

Cybersecurity disclaimer

This product is designed to be connected to and to communicate information and data via a network interface. It is Customer's sole responsibility to provide and continuously ensure a secure connection between the product and Customer network or any other network (as the case may be). Customer shall establish and maintain any appropriate measures (such as but not limited to the installation of firewalls, application of authentication measures, encryption of data, installation of anti-virus programs, etc) to protect the product, the network, its system and the interface against any kind of security breaches, unauthorized access, interference, intrusion, leakage and/or theft of data or information. ABB and its affiliates are not liable for damages and/or losses related to such security breaches, any unauthorized access, interference, intrusion, leakage and/or theft of data or information.

Contents

This manual is the Installation Manual for the ACS580 drive with bypass. Complete technical details are available in the [ACS580 Hardware manual](#), publication number [3AXD50000044794](#). Complete programming information is available in the [ACS580 control program firmware manual](#), publication number [3AXD50000016097](#).

To determine the type of your drive, refer to its construction code.

- Rating nameplate, type code (Panel P/N), job number and serial number labels are attached to the inside of the enclosure door on the non-hinged side.

ABB		
Environmental Type	1	480 Volts
34 FLA		3 Phase
25 Largest Motor (HP)		60 Hz
65 SCCR (kA) @ Rated voltage		
Drawing:		
ACS580-0P-034A-4 +F255+G310		
ABB Technical Support: 800-752-0696 UL File: E209528		

ABB		Job Number: J118392-1-1
Panel P/N: ACS580-0P-034A-4+F255+G310		
Panel S/N: 22109A0032	MFG S/N: 210326ACS580000001	
Drive P/N: ACS580-01-034A-4+P940		
Drive S/N: 2210504910		

Panel and Drive serial number: 2nd through 5th digits represents date of manufacture: year (e.g. 21) followed by week (01-52).

ACS580-0P with Bypass

Installation

This information is unique to ACS580 with two-contactor bypass (0P+F255+G310). This includes an ACS580 AC adjustable frequency drive packaged with circuit breaker with disconnect and a two-contactor bypass. Refer to the Electrical Installation - North America in the ACS580 Hardware Manual for all other information. **Failure to observe the warnings and instructions may cause malfunction or personal hazard.**



WARNING! Before you begin read [Safety instructions](#) on page 4.



WARNING! When the ACS580 with bypass is connected to the line power, the Motor Terminals T1, T2, and T3 are live even if the motor is not running. Do not make any connections when the ACS580 with bypass is connected to the line. Disconnect and lock out power to the drive before servicing the drive. Failure to disconnect power may cause serious injury or death.

1. Install wiring
-



WARNING!

- Metal shavings or debris in the enclosure can damage electrical equipment and create a hazardous condition. Where parts, such as conduit plates require cutting or drilling, first remove the part. If that is not practical, cover nearby electrical components to protect them from all shavings or debris.
- Do not connect or disconnect input or output power wiring, or control wires, when power is applied.
- Never connect line voltage to drive output Terminals T1, T2, and T3.
- Do not make any voltage tolerance tests (Hi Pot or Megger) on any part of the unit. Disconnect motor wires before taking any measurements in the motor or motor wires.
- Make sure that power factor correction capacitors are not connected between the drive and the motor.

Frame	Light Duty HP	UL (NEMA) Type 1			UL (NEMA) Type 12			UL (NEMA) Type 3R		
		Dim. Ref.	Filter E205 or E213	Electronic Overload (G418)	Dim. Ref.	Filter E205 or E213	Electronic Overload (G418)	Dim. Ref.	Filter E205 or E213	Electronic Overload (G418)
208 - 230 Volt Ratings										
R1	1 - 5	CX1-21			CX12-21	*	*	CX3R-21	*	*
R2	7.5 - 10	CX1-21	*		CX12-22			CX3R-22		
R3	15 - 20	CX1-22			CX12-22			CX3R-22		
R4	25	CX1-22			CX12-24			CX3R-23		
R5	30 - 40	CX1-23			CX12-24			CX3R-24		
R6	50	CX1-23			CX12-24			CX3R-24		
R7	60	CX1-24			CX12-24			CX3R-24		
R7	75	CX1-24			CX12-25			CX3R-25		
R8	100	CX1-24			CX12-25			CX3R-2		
460 Volt Ratings										
R1	1 - 7.5	CX1-21			CX12-21	*	*	CX3R-21	*	*
R2	10 - 15	CX1-21	*		CX12-22			CX3R-22		
R3	20 - 30	CX1-22			CX12-22			CX3R-22		
R4	40	CX1-22		*	CX12-23			CX3R-23		
R4	50	CX1-22		*	CX12-23	*		CX3R-23		
R4	60	CX1-22		*	CX12-24			CX3R-23		
R5	75	CX1-23			CX12-24			CX3R-24		
R6	100	CX1-23			CX12-24			CX3R-24		
R7	125 - 150	CX1-24			CX12-24			CX3R-24		
R8	200	CX1-24			CX12-25			CX3R-25		
R9	250 - 350	CX1-25			CX12-26			NA		
575 Volt Ratings										
R2	2 - 15	CX1-21	*		CX12-22			CX3R-22		
R3	20 - 30	CX1-22			CX12-22			CX3R-22		
R5	40	CX1-22			CX12-23			CX3R-23		
R5	50	CX1-22			CX12-23	*				
R5	60	CX1-22			CX1-24			CX3R-23		
R5	75	CX1-23			CX1-24			CX3R-23		
R7	100 - 125	CX1-24			CX1-24			CX3R-24		
R8	150	CX1-24	*		CX1-24			CX3R-24		

*Enclosure size increases by one rating when indicated option is included. In no case will the enclosure size increase by more than one rating even if G418 is included with E205 and/or E213.

Connection diagrams - UL Type 1

ACS580-0P Type 1 units are configured for wiring access from the top and bottom. Top is dedicated for entry; the bottom for exit. The following figures show the layout and wiring connection points. For drive control wiring see Connecting the control

cables in [ACS580 Hardware Manual](#). Maintain appropriate separation of control and power wires.

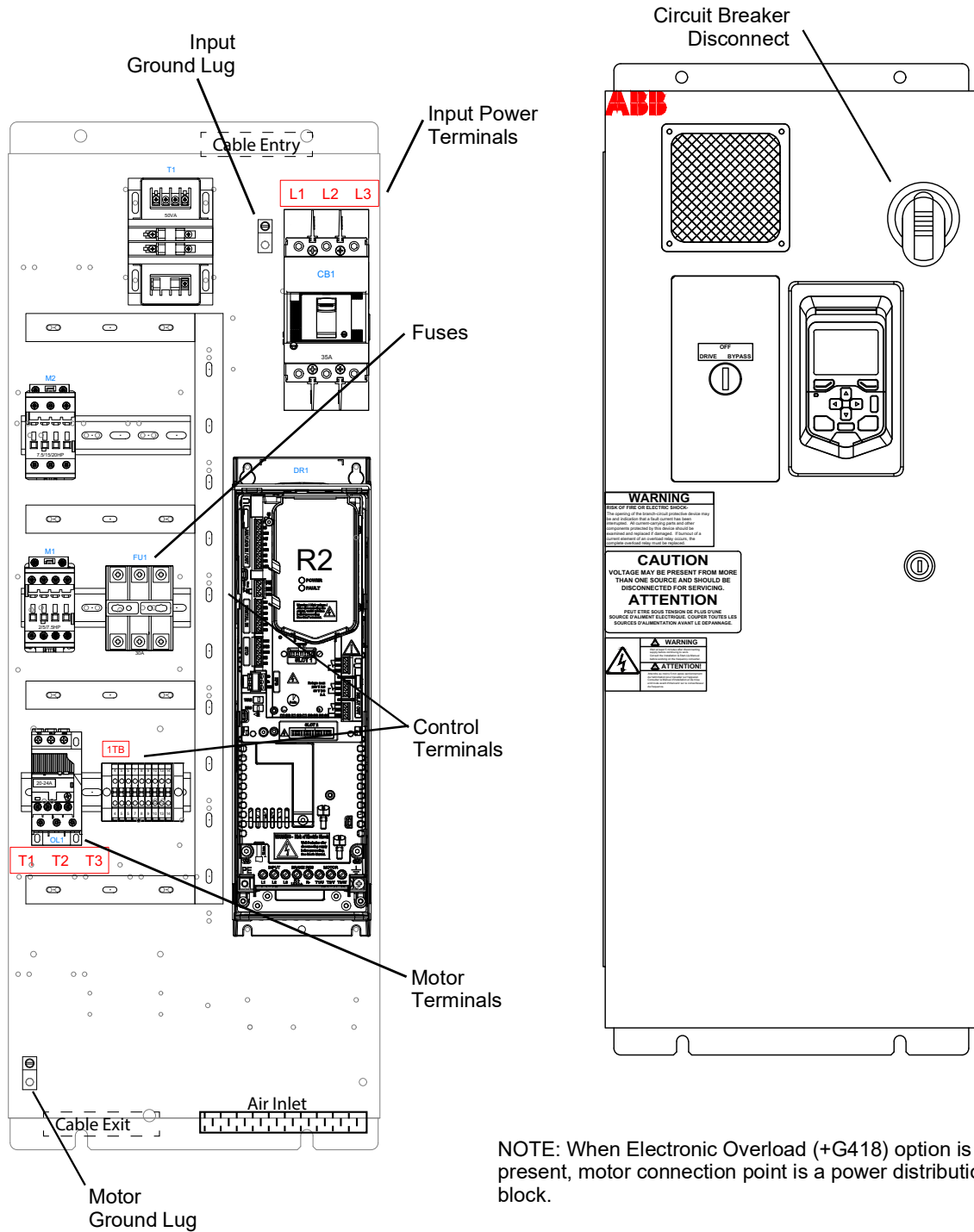

NOTE: When Electronic Overload (+G418) option is present, motor connection point is a power distribution block.

Allow 2" between enclosures for door swing

CX1-21

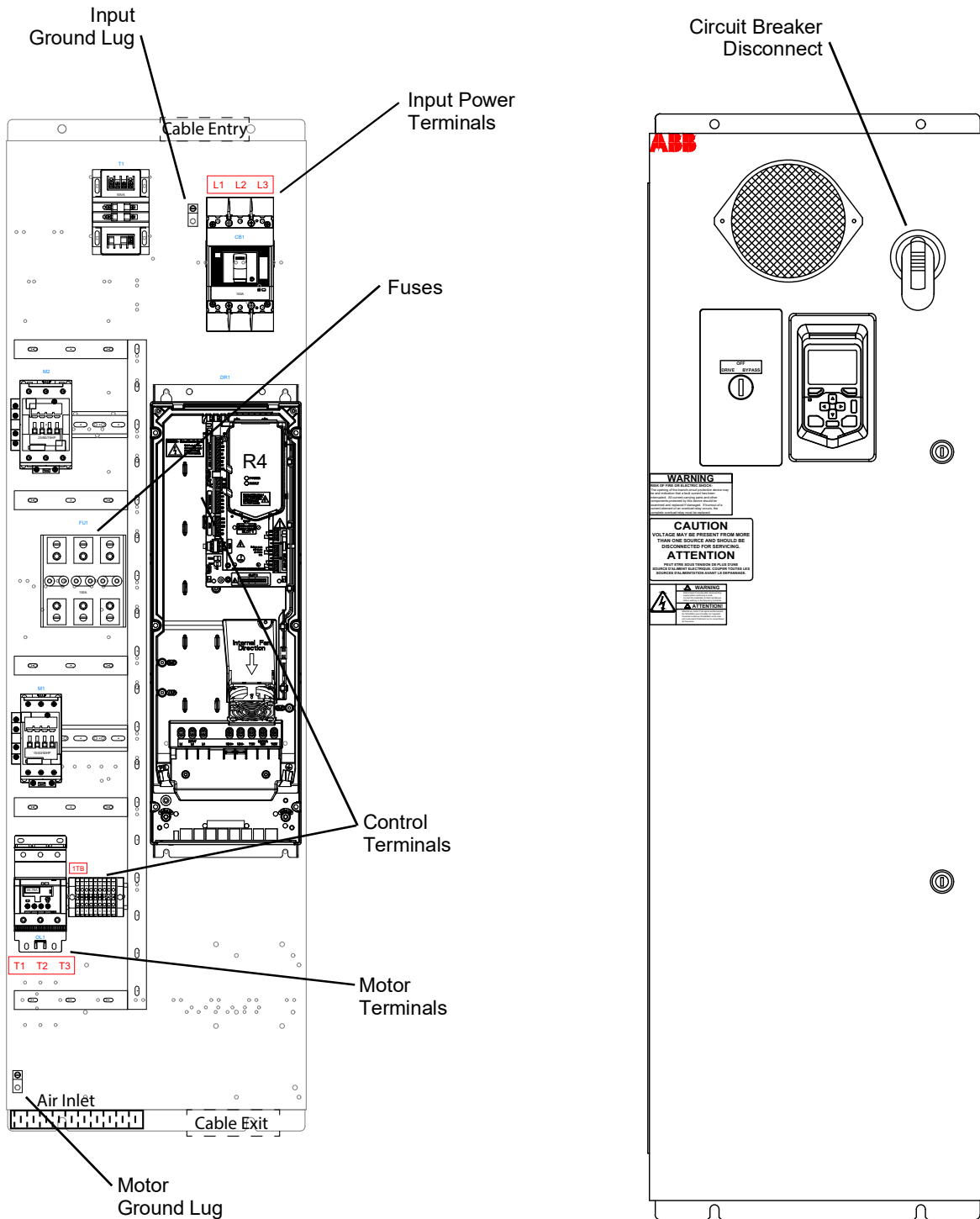

CX1-22

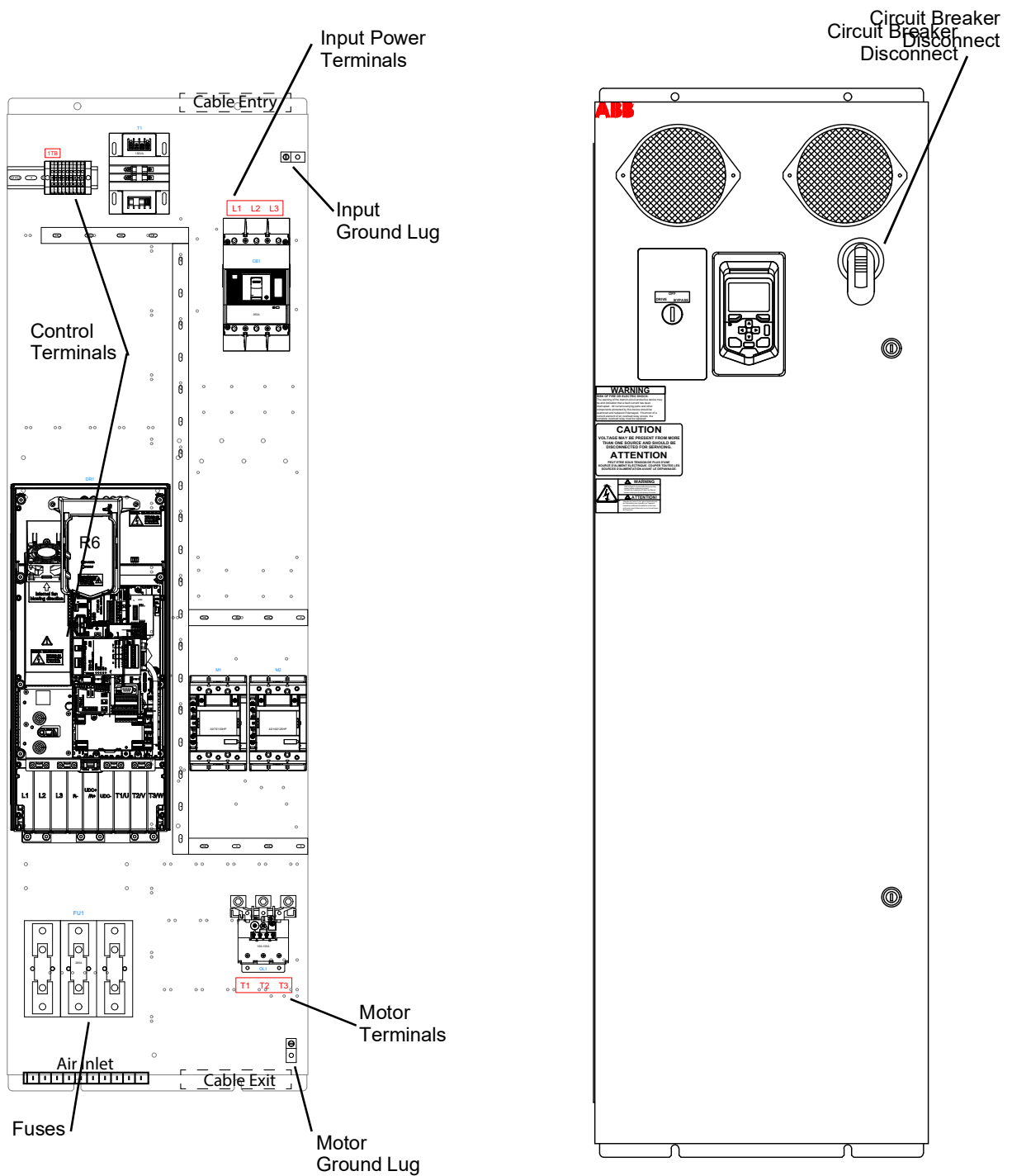

NOTE: When Electronic Overload (+G418) option is present, motor connection point is a power distribution block.

CX1-23

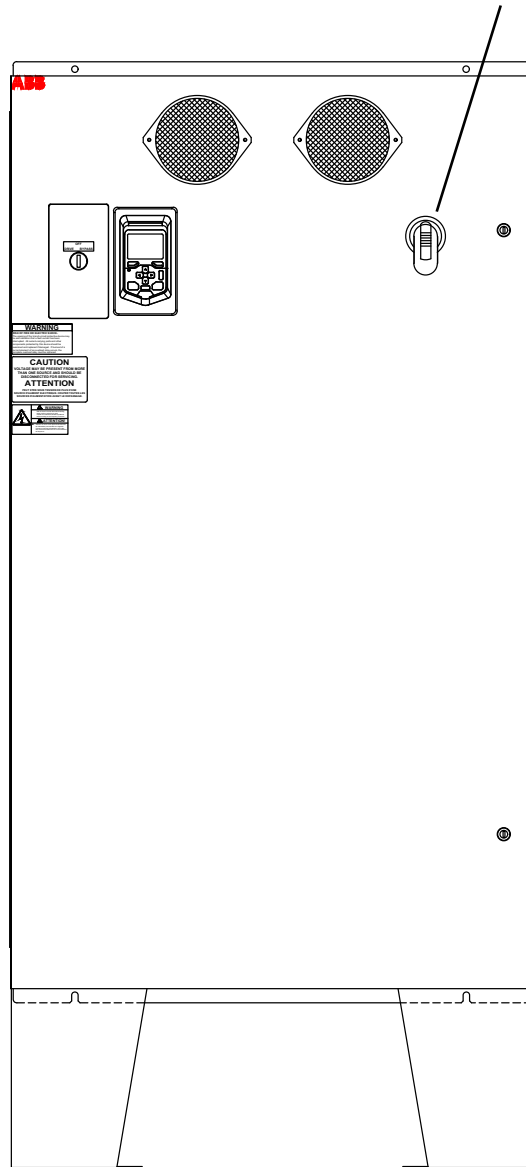
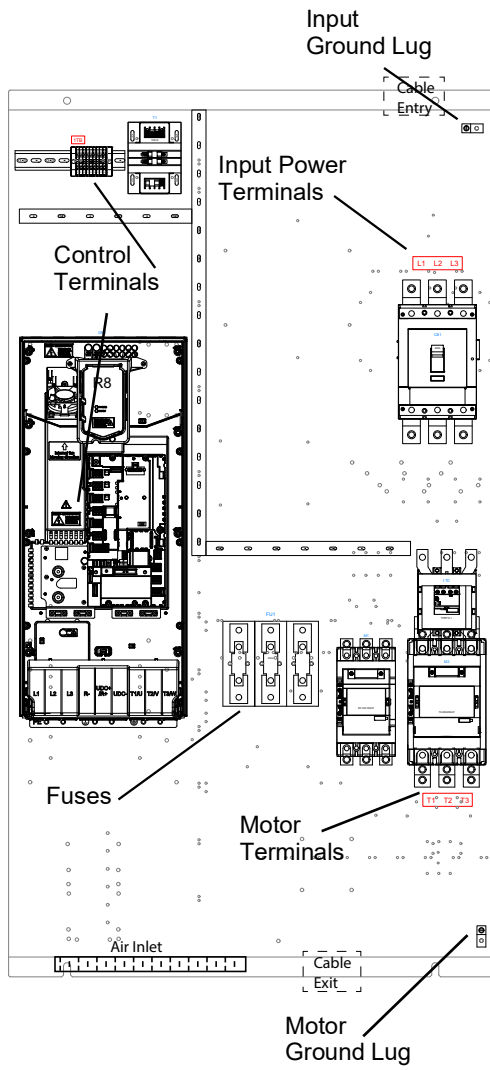

CX1-24

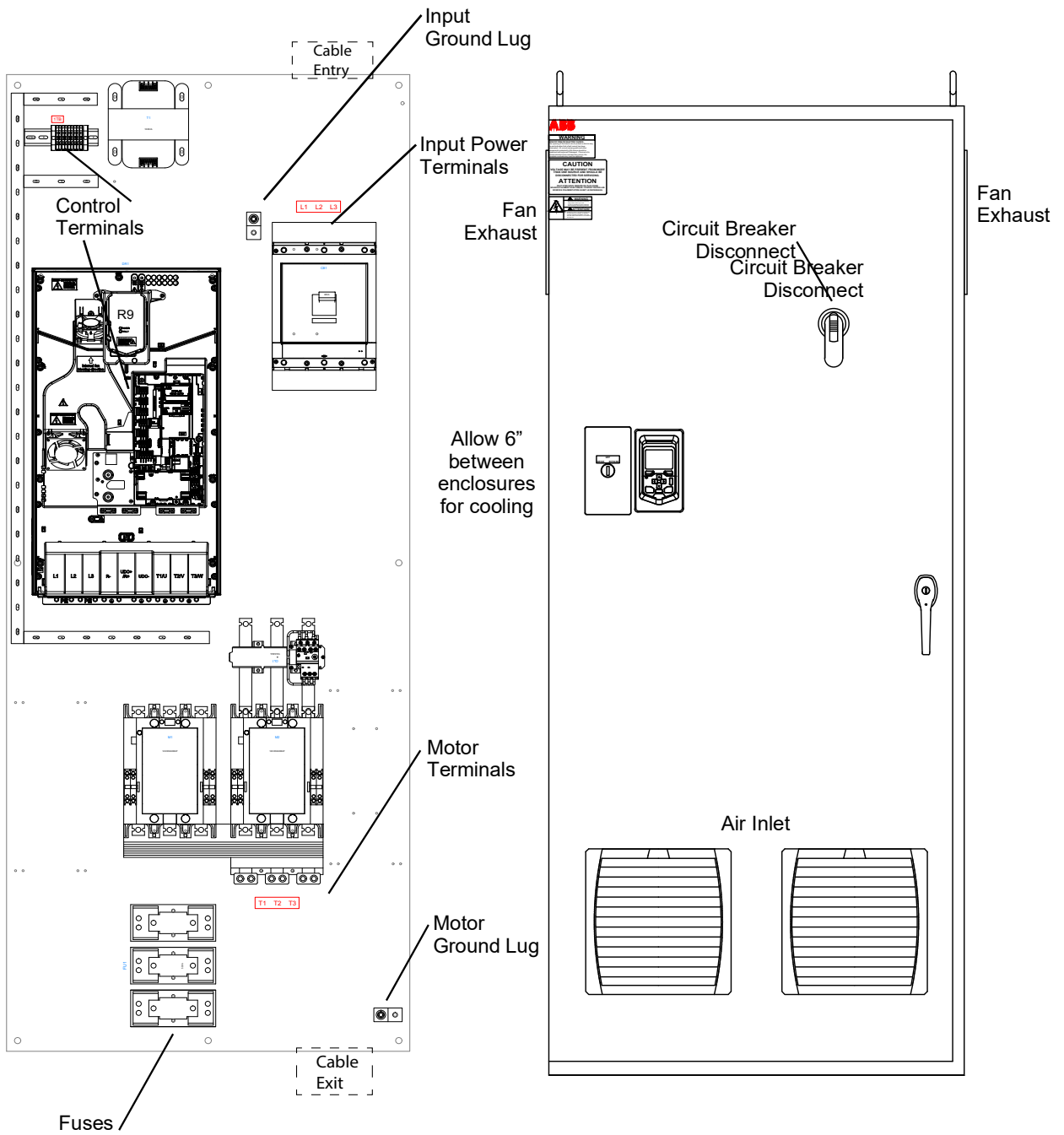

CX1-25

Connection diagrams - UL Type 12

ACS580-0P Type 12 units are configured for wiring access from the top and bottom. Top is dedicated for entry; the bottom for exit. The following figures show the layout and wiring connection points. For drive control wiring see section Connecting the control cables in *ACS580 Hardware Manual*. Maintain appropriate separation of control and power wires.

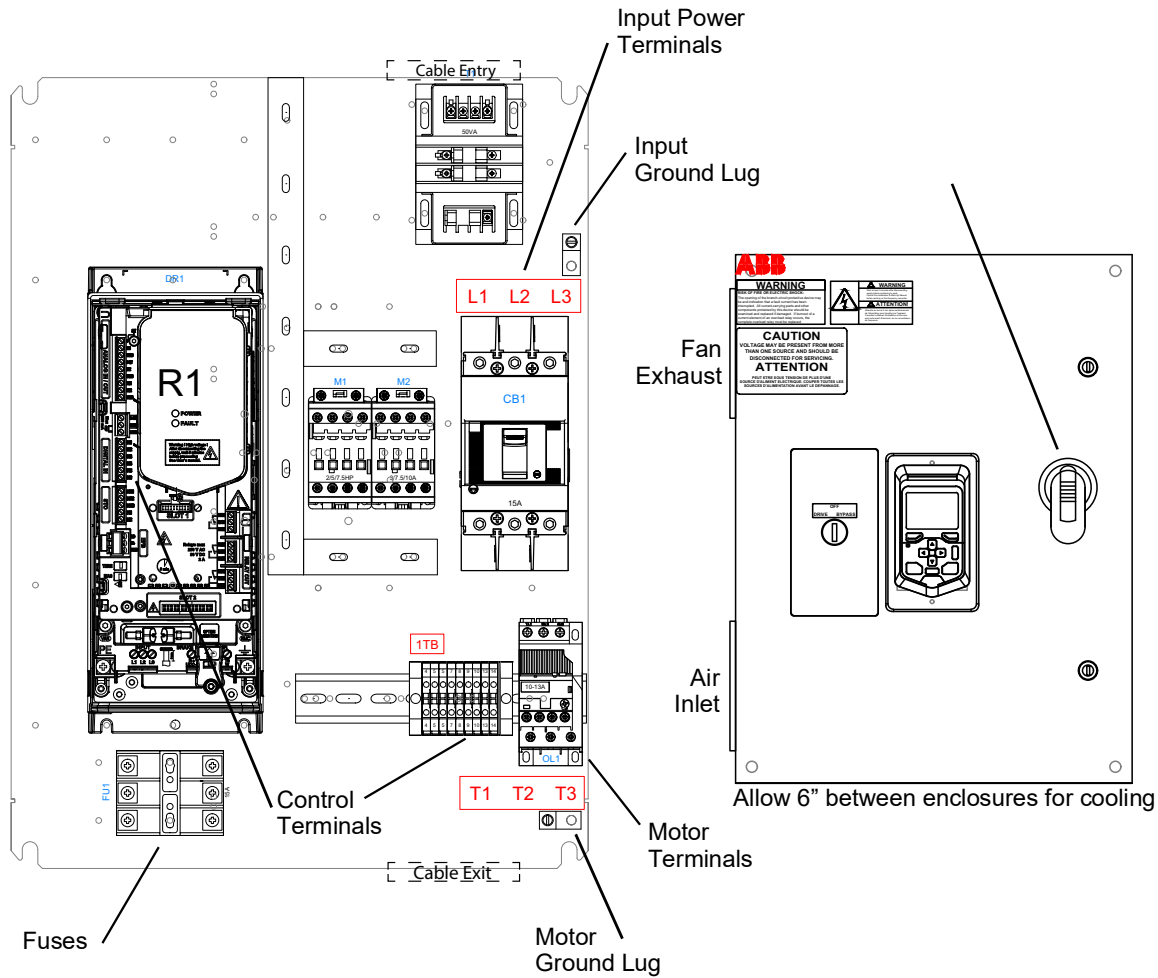

CX12-21

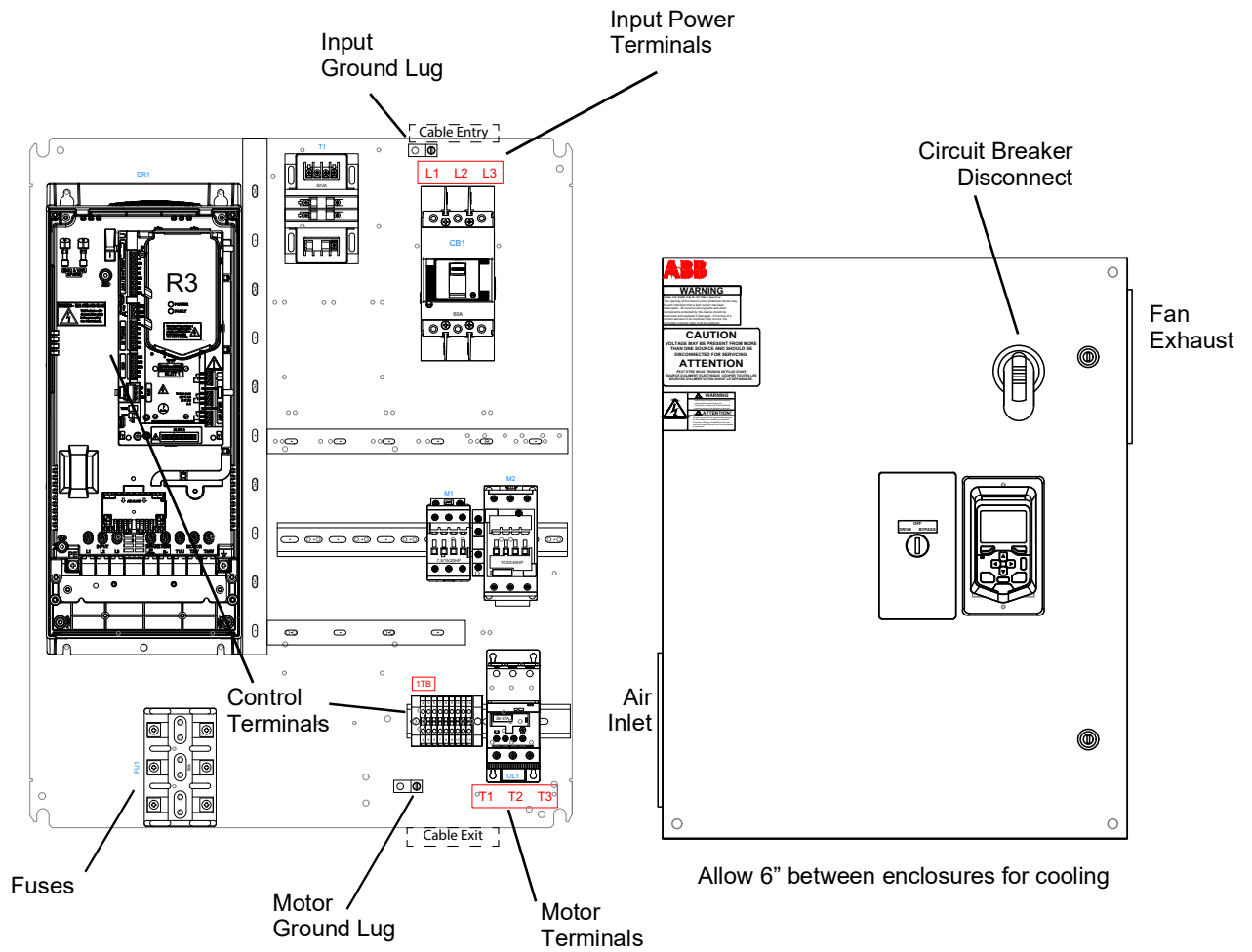

CX12-22, CX12-23

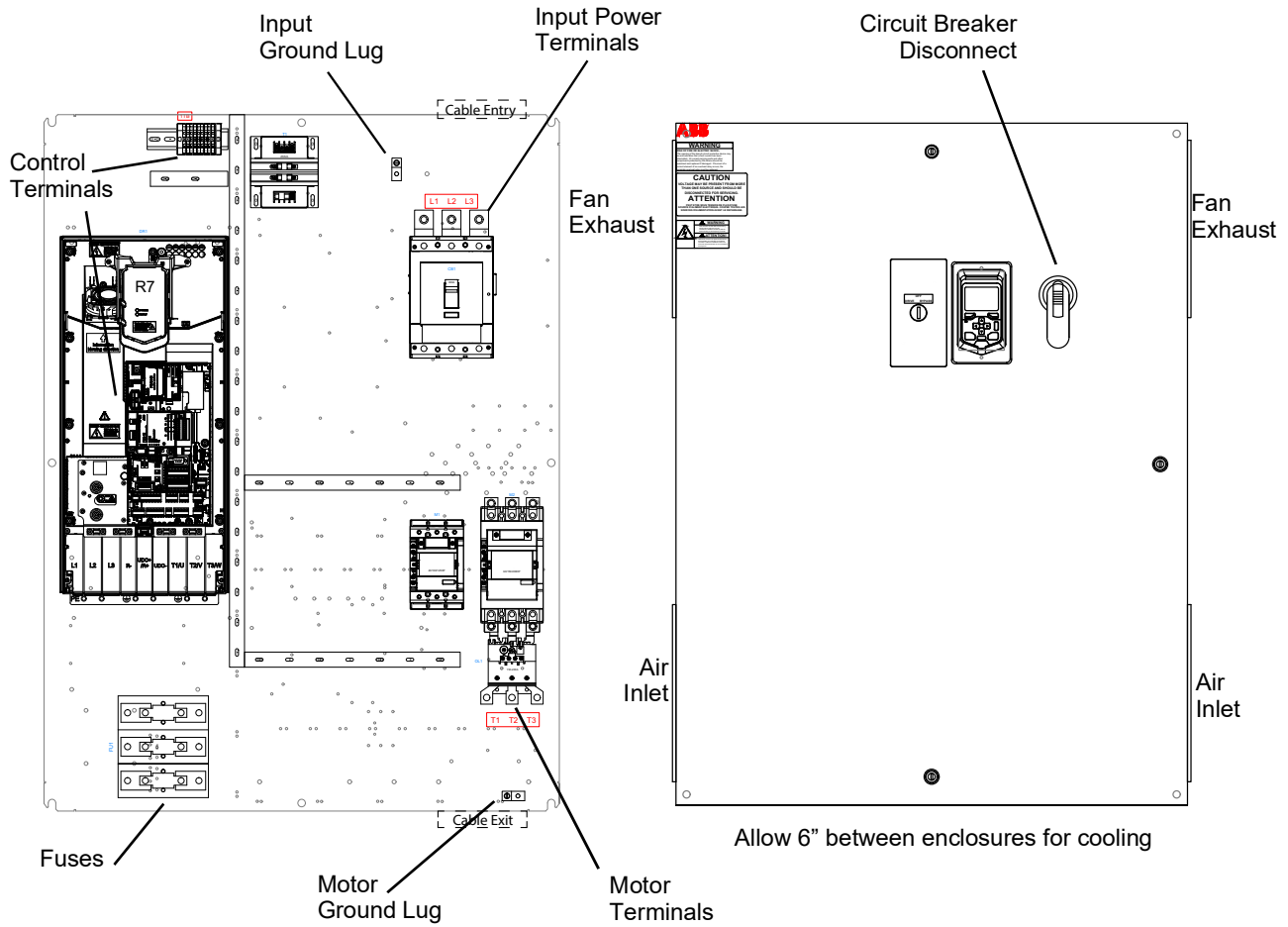

CX12-24

Allow 6" between enclosures for cooling

Motor Ground Lug

CX12-25

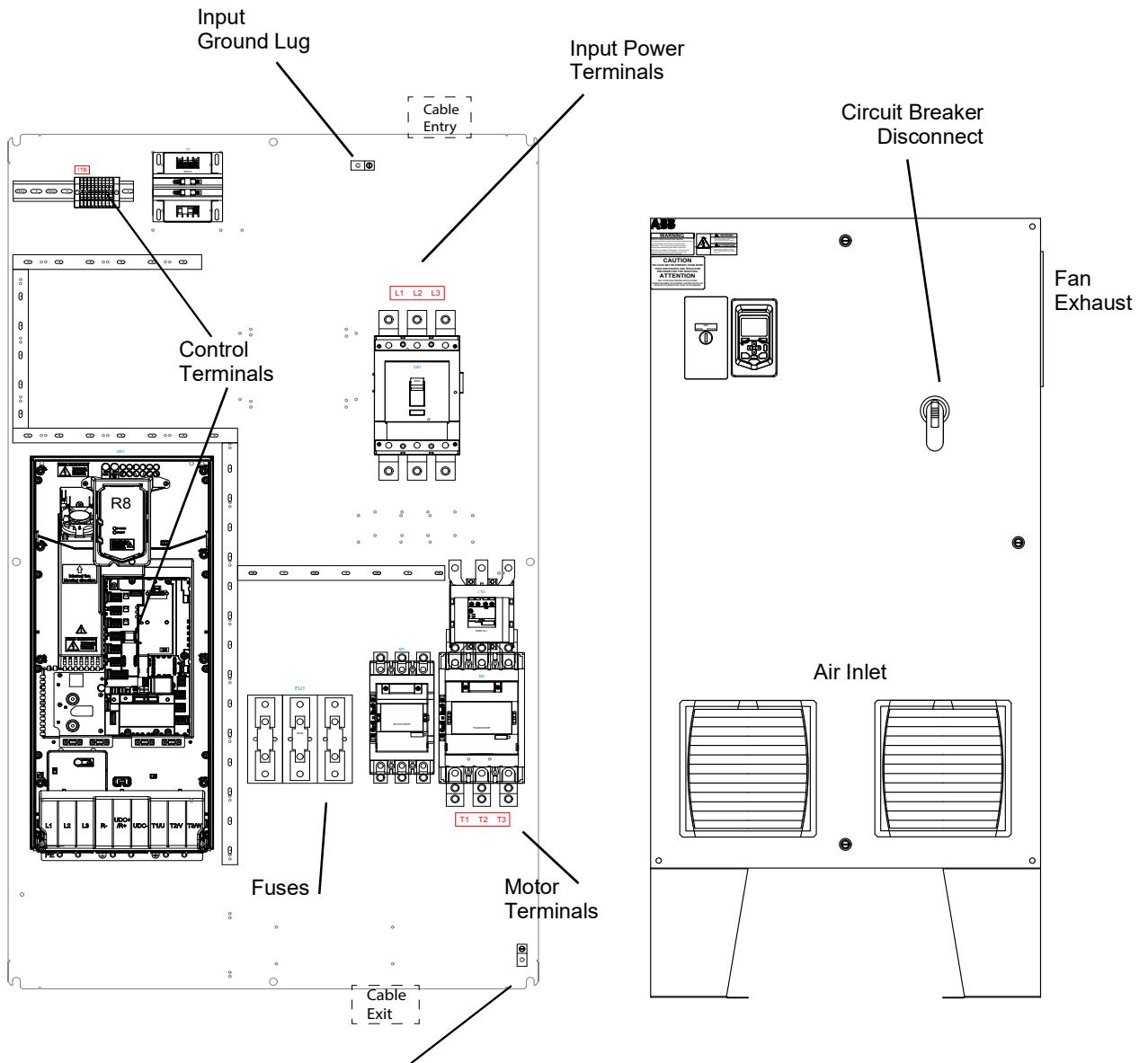

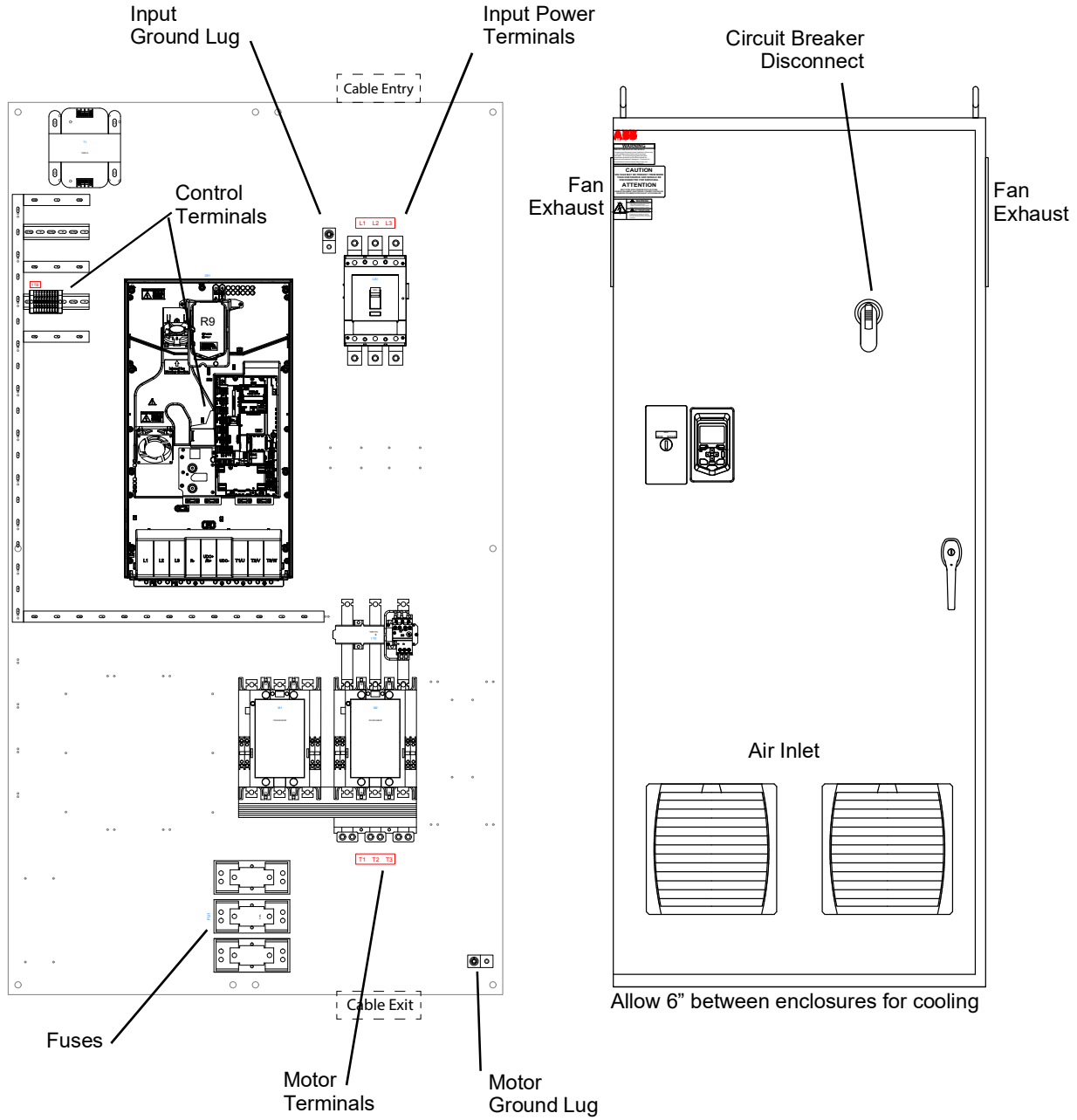

CX12-26

Connection diagrams - UL Type 3R

ACS580-0P Type 3R units are configured for wiring access from the bottom for entry and exit. The following figures show the layout and wiring connection points. For drive control wiring see section Connecting the control cables in the [ACS580 Hardware Manual](#). Maintain appropriate separation of control and power wires.

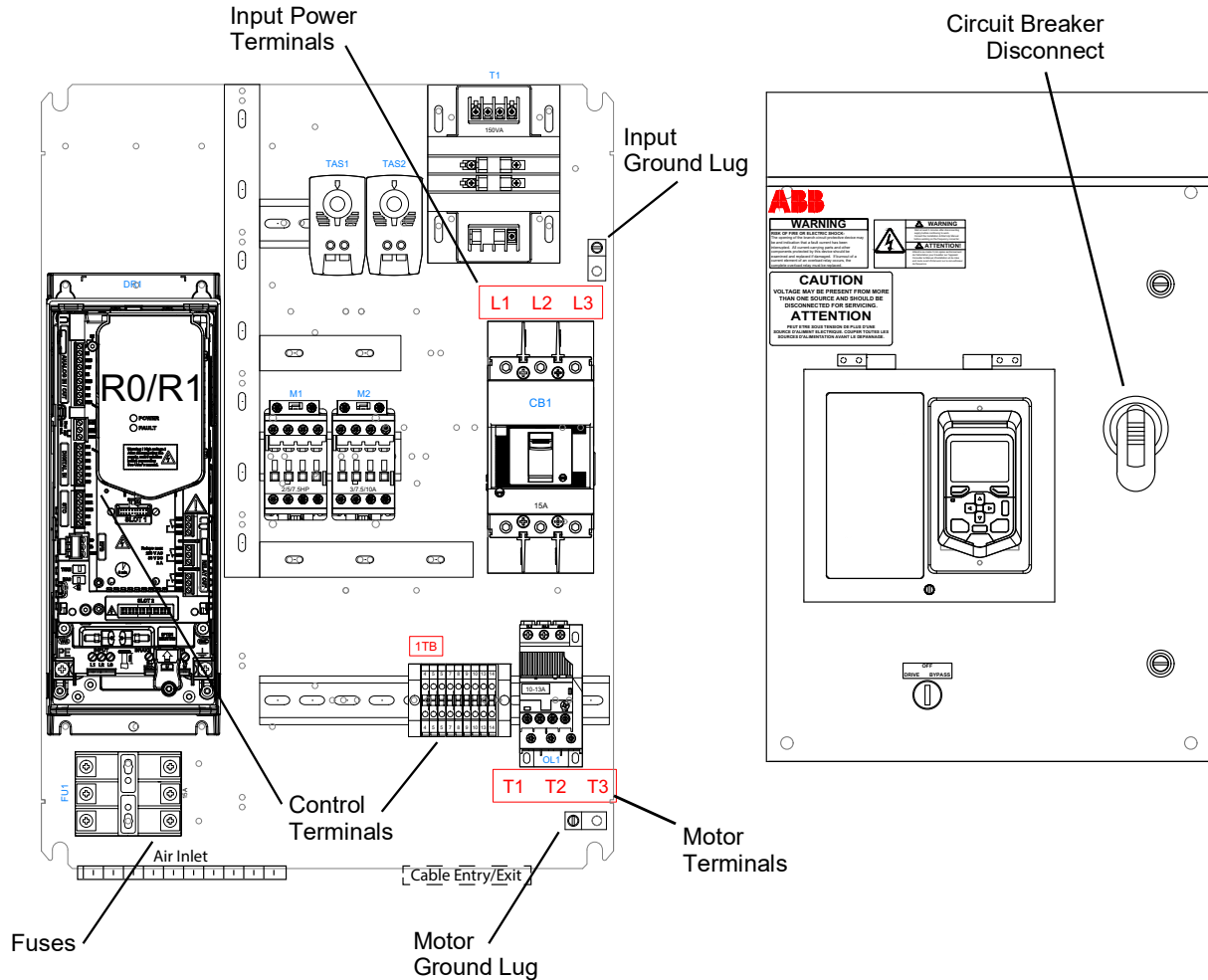

CX3R-21

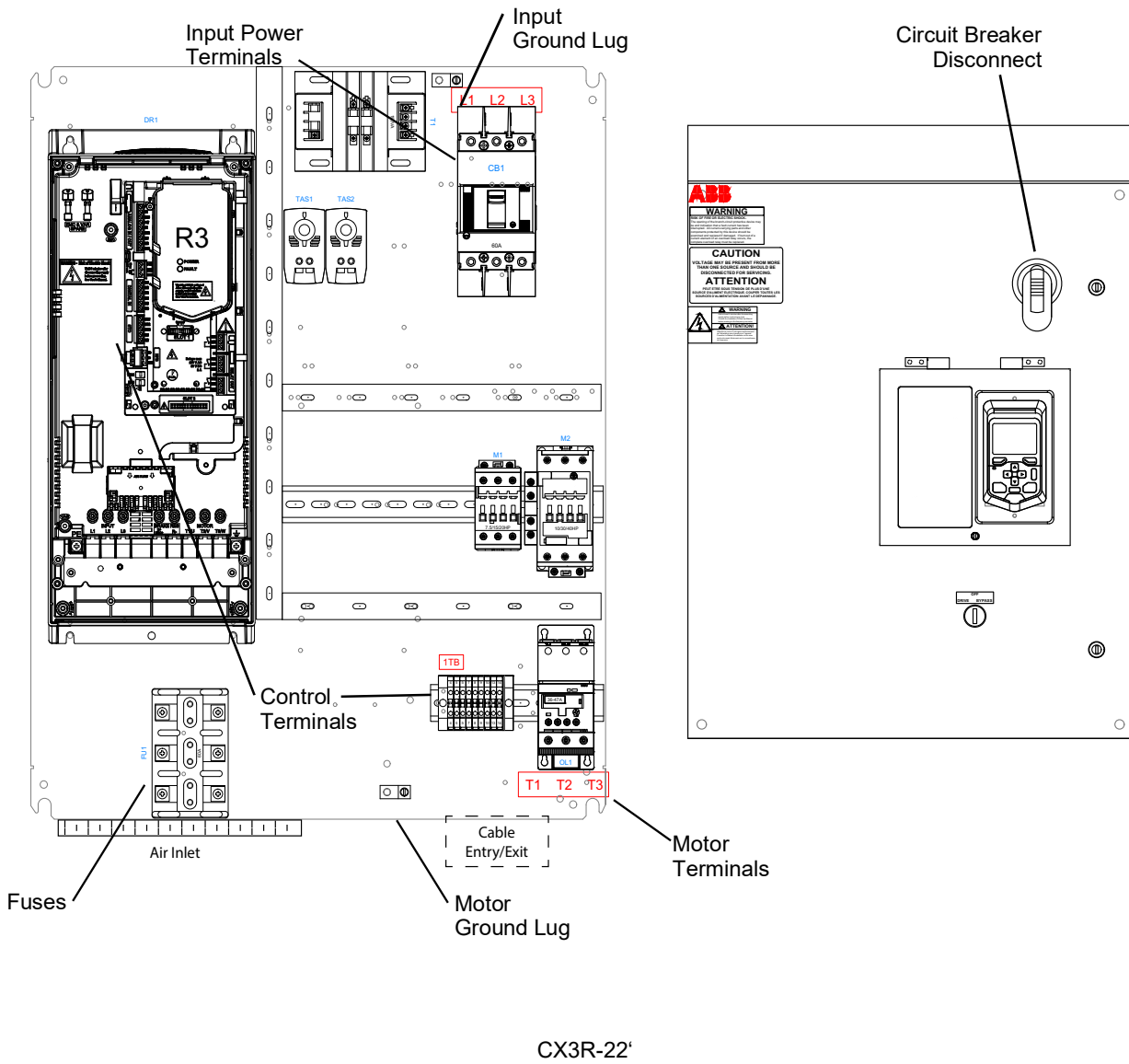

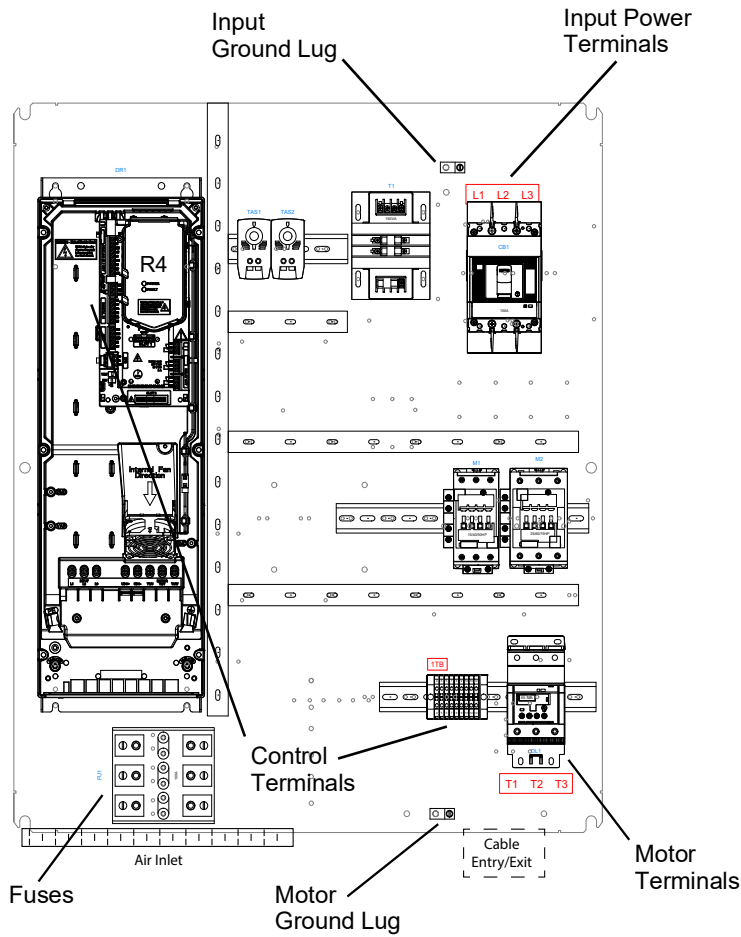

CX3R-23

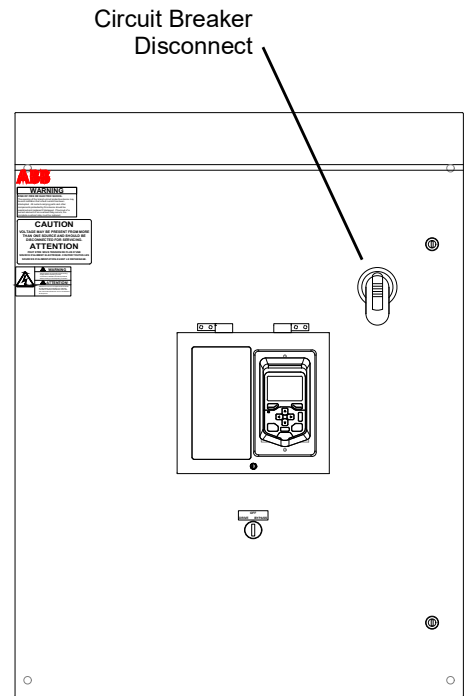

Allow 2" between enclosures for door swing.

NOTE: When Electronic Overload (+G418) option is present, motor connection point is a power distribution block

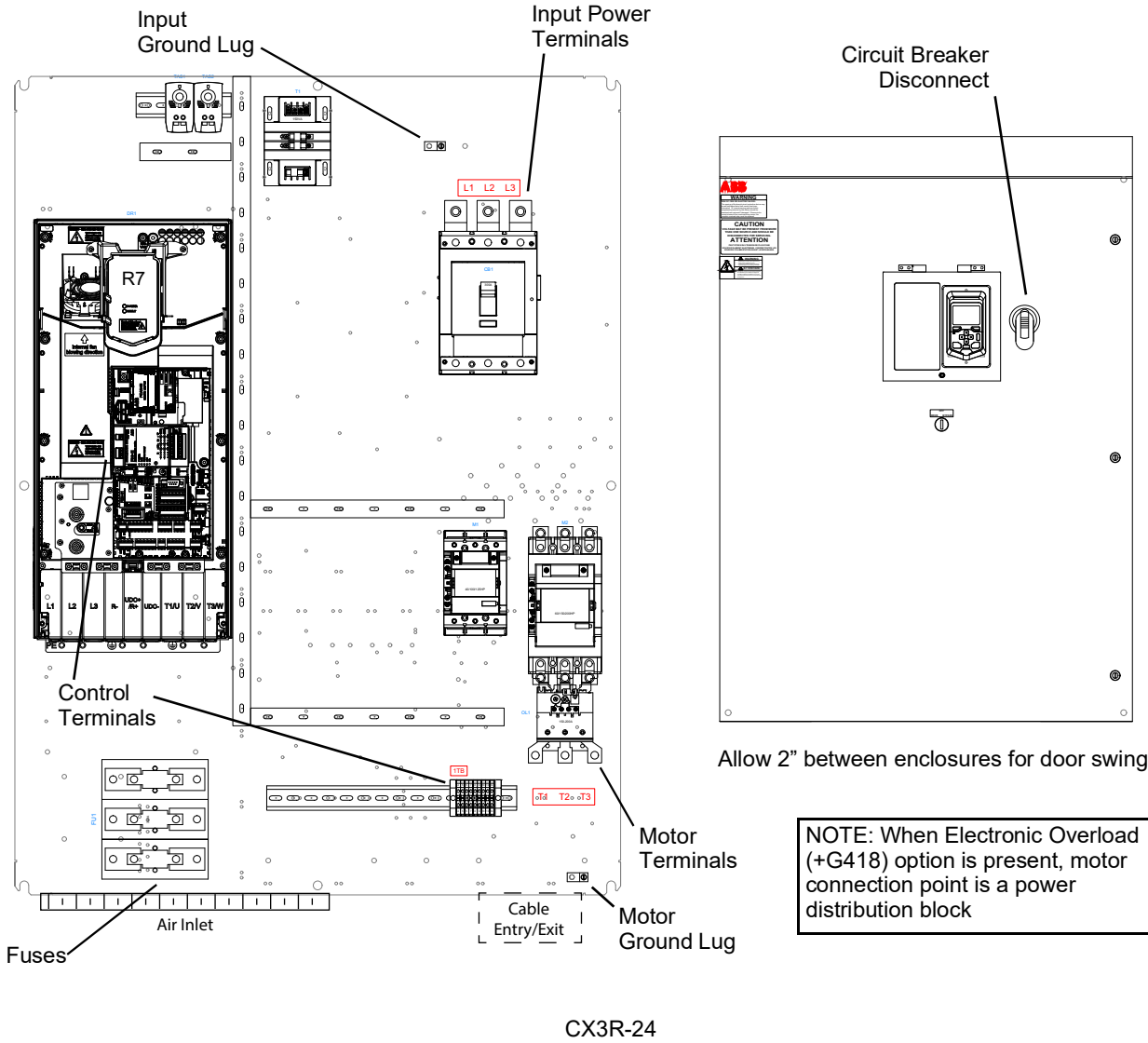

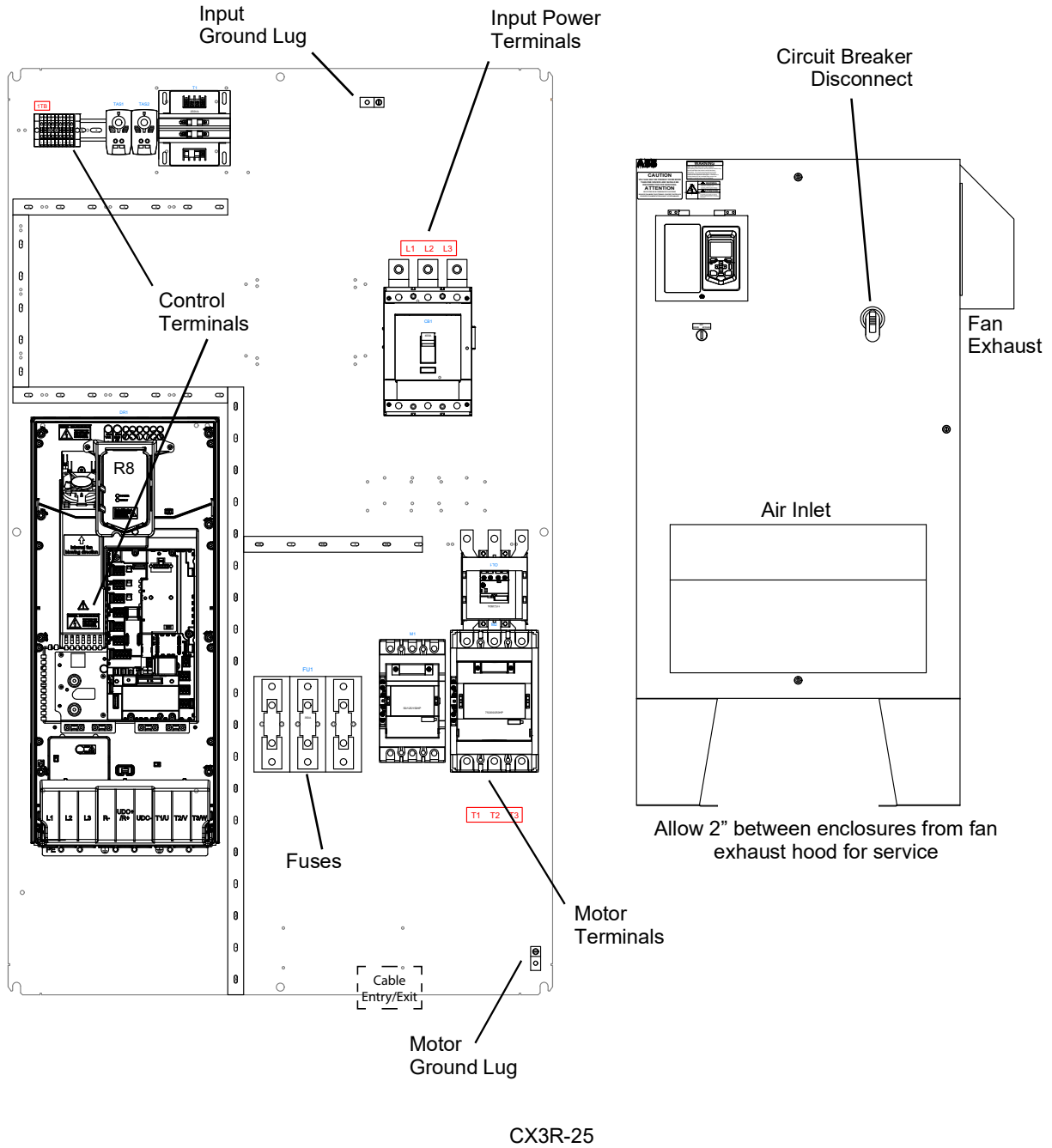

Power connection terminals

The following tables show maximum wire size and required tightening torque for incoming power, grounding and motor terminals.

208/230 Volt Type Code ¹	Output Ratings		Base Drive Frame Size	Terminal Wire Range			
	Amps	HP		Circuit Breaker	Motor Terminals (Standard)	Motor Terminals (G418)	Ground Lugs UL
ACS580-0P-04A6-2+F255+G310	4.6	1	R1	#14...#1/0 5.2 lbf-ft	#18...#10 1.1...1.8 lbf-ft	#14...#2 3.0...4.1 lbf-ft	#14...#2 3.3 lbf-ft
ACS580-0P-06A6-2+F255+G310	6.6	1.5	R1				
ACS580-0P-07A5-2+F255+G310	7.5	2	R1				
ACS580-0P-10A6-2+F255+G310	10.6	3	R1				
ACS580-0P-017A-2+F255+G310	17	5	R1				
ACS580-0P-024A-2+F255+G310	24	7.5	R2				
ACS580-0P-031A-2+F255+G310	31	10	R2				
ACS580-0P-046A-2+F255+G310	46	15	R3	#4...300MCM 6.6 lbf-ft	#12...#2 2.9...3.3 lbf-ft	#8...#2/0 9.1 lbf-ft	#14...#2 3.3 lbf-ft
ACS580-0P-059A-2+F255+G310	59	20	R3				
ACS580-0P-075A-2+F255+G310	75	25	R4				
ACS580-0P-088A-2+F255+G310	88	30	R5				
ACS580-0P-114A-2+F255+G310	114	40	R5				
ACS580-0P-143A-2+F255+G310	143	50	R6				
ACS580-0P-169A-2+F255+G310	169	60	R7				
ACS580-0P-211A-2+F255+G310	211	75	R7	(2) #3/0... 500MCM 22.9 lbf-ft	#6...250MCM 22.9 lbf-ft	#6...300MCM 25 lbf-ft	#14...#2/0 4.1...10 lbf-ft
ACS580-0P-273A-2+F255+G310	273	100	R8				

460 Volt							
Type Code	Output Ratings		Base Drive Frame Size	Terminal Wire Range			
	Amps	HP		Circuit Breaker	Motor Terminals (Standard)	Motor Terminals (G418)	Ground Lugs UL
ACS580-0P-02A1-4+F255+G310	2.1	1	R1				
ACS580-0P-03A0-4+F255+G310	3	1.5	R1				
ACS580-0P-03A5-4+F255+G310	3.5	2	R1				
ACS580-0P-04A8-4+F255+G310	4.8	3	R1				
ACS580-0P-07A6-4+F255+G310	7.6	5	R1				
ACS580-0P-012A-4+F255+G310	12	7.5	R1	#14...#1/0 5.2 lbf-ft	#18...#10 5.2 lbf-ft	#14...#2 3.0...4.1 lbf-ft	
ACS580-0P-014A-4+F255+G310	14	10	R2				
ACS580-0P-023A-4+F255+G310	23	15	R2				
ACS580-0P-027A-4+F255+G310	27	20	R3				
ACS580-0P-034A-4+F255+G310	34	25	R3				
ACS580-0P-044A-4+F255+G310	44	30	R3				
ACS580-0P-052A-4+F255+G310	52	40	R4				
ACS580-0P-065A-4+F255+G310	65	50	R4				
ACS580-0P-077A-4+F255+G310	77	60	R4				
							#14...#1/0 3.3...4.21 lbf-ft
ACS580-0P-096A-4+F255+G310	96	75	R5				
ACS580-0P-124A-4+F255+G310	124	100	R6	#4...300MCM 6.6 lbf-ft	#6...#2/0 6.4...7.3 lbf-ft	#14...#2/0 4.1...10 lbf-ft	
ACS580-0P-156A-4+F255+G310	156	125	R7		#6...250MCM 22.9 lbf-ft	#6...300MCM 25 lbf-ft	
ACS580-0P-180A-4+F255+G310	180	150	R7		22.9 lbf-ft	#6...300MCM 25 lbf-ft	
ACS580-0P-240A-4+F255+G310	240	200	R8	(2) #3/0... 500MCM 22.9 lbf-ft	(2) #4...500MCM 31 lbf-ft		
ACS580-0P-302A-4+F255+G310	302	250	R9		(2) #2/ 0...500MCM 22.9 lbf-fy	NA	
ACS580-0P-361A-4+F255+G310	361	300	R9				
ACS580-0P-414A-4+F255+G310	414	350	R9				#6...350MCM 22.9 lbf-ft

575 Volt							
Type Code	Output Ratings		Base Drive Frame Size	Terminal Wire Range			
	Amps	HP		Circuit Breaker	Motor Terminals (Standard)	Motor Terminals (G418)	Ground Lugs UL
ACS580-0P-02A7-6+F255+G310	2.7	2	R2				
ACS580-0P-03A9-6+F255+G310	3.9	3	R2				
ACS580-0P-06A1-6+F255+G310	6.1	5	R2				
ACS580-0P-09A0-6+F255+G310	9	7.5	R2				
ACS580-0P-011A-6+F255+G310	11	10	R2		#18...#10 3.0...4.1 lbf-ft	#14...#2 3.0...4.1 lbf-ft	
ACS580-0P-017A-6+F255+G310	17	15	R2				
ACS580-0P-022A-6+F255+G310	22	20	R3	#14...#1/0			
ACS580-0P-027A-6+F255+G310	27	25	R3	5.2 lbf-ft			
ACS580-0P-032A-6+F255+G310	32	30	R3				#14...#2 3.3 lbf-ft
ACS580-0P-041A-6+F255+G310	41	40	R5		#12...#2 2.9...3.3 lbf-ft		
ACS580-0P-052A-6+F255+G310	52	50	R5			#8...#2/0	
ACS580-0P-062A-6+F255+G310	62	60	R6		#8...#1 4.8...6.6 lbf-ft	9.1 lbf-ft	
ACS580-0P-077A-6+F255+G310	77	75	R6				
ACS580-0P-099A-6+F255+G310	99	100	R7		#6...#2/0	#14...#2/0	
ACS580-0P-125A-6+F255+G310	125	125	R7	#4...300MCM	6.4...7.3 lbf-ft	4.1...10 lbf-ft	
ACS580-0P-144A-6+F255+G310	144	150	R8	6.6 lbf-ft	#6...250MCM 22.9 lbf-ft	#6...300MCM 25 lbf-ft	

Branch circuit protection

Input power is connected to the ACS580 through a door interlocked circuit breaker. When connected to a 240V or 480V power source, the ACS580 with circuit breaker is suitable for use on a circuit capable of delivering not more than 65,000 RMS symmetrical amperes. When connected to a 600V power source, it is suitable for use on a circuit capable of delivering not more than 10,000 RMS symmetrical amperes.

Fuses

Note: The UL listed drive fuses in the table are provided in the purchased product.

- Replacement fuses are required to be of the same class, current rating, and voltage rating. Fuses from other manufacturers can be used if they are 600V rated and meet the specifications given in the table.
- Fuses with higher current rating than specified must not be used.

208/230 Volt fuses for packaged drive

208/230 Volt Type code	Nominal Output Range		Base Drive Frame Size	Internal Drive Fuse Rating		Bypass Fuse Rating (only with Type EF Electronic Overload)*	
	Drive current	Package power		Class	Current rating (Amps)	Class	Current rating (Amps)
	A	HP					
ACS580-0P-04A6-2+F255+G310	4.6	1	R1	Class CC	15	Class J	10
ACS580-0P-06A6-2+F255+G310	6.6	1.5	R1	Class CC	15	Class J	15
ACS580-0P-07A5-2+F255+G310	7.5	2	R1	Class CC	15	Class J	15
ACS580-0P-10A6-2+F255+G310	10.6	3	R1	Class CC	15	Class J	20
ACS580-0P-017A-2+F255+G310	16.7	5	R1	Class CC	30	Class J	30
ACS580-0P-024A-2+F255+G310	24.2	7.5	R2	Class CC	30	Class J	40
ACS580-0P-031A-2+F255+G310	30.8	10	R2	Class T	40	Class J	60
ACS580-0P-046A-2+F255+G310	46.2	15	R3	Class T	80	Class J	80
ACS580-0P-059A-2+F255+G310	59.4	20	R3	Class T	80	Class J	100
ACS580-0P-075A-2+F255+G310	74.8	25	R4	Class T	100	Class J	125
ACS580-0P-088A-2+F255+G310	88	30	R5	Class T	110	Class J	175
ACS580-0P-114A-2+F255+G310	114	40	R5	Class T	150	Class J	200
ACS580-0P-143A-2+F255+G310	143	50	R6	Class T	200	Class J	225
ACS580-0P-169A-2+F255+G310	169	60	R7	Class T	250	Class J	300
ACS580-0P-211A-2+F255+G310	211	75	R7	Class T	300	Class J	400
ACS580-0P-273A-2+F255+G310	273	100	R8	Class T	350	n/a	n/a

460 Volt fuses for packaged drive

480 Volt Type code	Nominal Output Range		Base Drive Frame Size	Internal Drive Fuse Rating		Bypass Fuse Rating (only with Type EF Electronic Overload)*	
	Drive current	Package power		Class	Current rating (Amps)	Class	Current rating (Amps)
	A	HP					
ACS580-0P-02A1-4+F255+G310	2.1	1	R1	Class CC	15	Class J	10
ACS580-0P-03A0-4+F255+G310	3	1.5	R1	Class CC	15	Class J	10
ACS580-0P-03A5-4+F255+G310	3.5	2	R1	Class CC	15	Class J	10
ACS580-0P-04A8-4+F255+G310	4.8	3	R1	Class CC	15	Class J	10
ACS580-0P-07A6-4+F255+G310	7.6	5	R1	Class CC	15	Class J	15
ACS580-0P-012A-4+F255+G310	12	7.5	R1	Class CC	15	Class J	20
ACS580-0P-014A-4+F255+G310	14	10	R2	Class CC	30	Class J	25
ACS580-0P-023A-4+F255+G310	23	15	R2	Class CC	30	Class J	30
ACS580-0P-027A-4+F255+G310	27	20	R3	Class T	40	Class J	50
ACS580-0P-034A-4+F255+G310	34	25	R3	Class T	60	Class J	60
ACS580-0P-044A-4+F255+G310	44	30	R3	Class T	60	Class J	60
ACS580-0P-052A-4+F255+G310	52	40	R4	Class T	80	Class J	100
ACS580-0P-065A-4+F255+G310	65	50	R4	Class T	100	Class J	100
ACS580-0P-077A-4+F255+G310	77	60	R4	Class T	100	Class J	125
ACS580-0P-096A-4+F255+G310	96	75	R5	Class T	150	Class J	175
ACS580-0P-124A-4+F255+G310	124	100	R6	Class T	200	Class J	200
ACS580-0P-156A-4+F255+G310	156	125	R7	Class T	225	Class J	250
ACS580-0P-180A-4+F255+G310	180	150	R7	Class T	300	Class J	300
ACS580-0P-240A-4+F255+G310	240	200	R8	Class T	350	N/A	N/A
ACS580-0P-302A-4+F255+G310	302	250	R9	Class T	500	N/A	N/A
ACS580-0P-361A-4+F255+G310	361	300	R9	Class T	500	N/A	N/A
ACS580-0P-414A-4+F255+G310	414	350	R9	Class T	600	N/A	N/A

575 Volt fuses for packaged drive

575 Volt Type code	Nominal Output Range		Base Drive Frame Size	Internal Drive Fuse Rating		Bypass Fuse Rating (only with Type EF Electronic Overload)*	
	Drive current	Package power		Class	Current rating (amps)	Class	Current rating (amps)
	A	HP					
ACS580-0P-02A7-6+F255+G310	2.7	2	R2	Class CC	15	Class J	10
ACS580-0P-03A9-6+F255+G310	3.9	3	R2	Class CC	15	Class J	10
ACS580-0P-06A1-6+F255+G310	6.1	5	R2	Class CC	15	Class J	10
ACS580-0P-09A0-6+F255+G310	9	7.5	R2	Class CC	15	Class J	15
ACS580-0P-011A-6+F255+G310	11	10	R2	Class CC	15	Class J	20
ACS580-0P-017A-6+F255+G310	17	15	R2	Class CC	30	Class J	30
ACS580-0P-022A-6+F255+G310	22	20	R3	Class T	40	Class J	40
ACS580-0P-027A-6+F255+G310	27	25	R3	Class T	40	Class J	50
ACS580-0P-032A-6+F255+G310	32	30	R3	Class T	40	Class J	50
ACS580-0P-041A-6+F255+G310	41	40	R5	Class T	50	Class J	70
ACS580-0P-052A-6+F255+G310	52	50	R5	Class T	80	Class J	80
ACS580-0P-062A-6+F255+G310	62	60	R5	Class T	80	Class J	100
ACS580-0P-077A-6+F255+G310	77	75	R5	Class T	100	Class J	125
ACS580-0P-099A-6+F255+G310	99	100	R7	Class T	150	Class J	150
ACS580-0P-125A-6+F255+G310	125	125	R7	Class T	175	Class J	200
ACS580-0P-144A-6+F255+G310	144	150	R8	Class T	200	n/a	n/a

*When G418 option is included and on all R8 and R9 drives. (See [page 9](#))

Operation

This information is unique to ACS580 bypass configurations (0P+F255+G310). This drive system uses the ACS580-01 Hand/Auto macro for run operation. See section Control Macros, Hand/Auto Macro in the ACS580 Standard Control Program Firmware Manual page 90 for complete information.

Input disconnect configuration

The ACS580-0P with bypass is an ACS580 AC adjustable frequency drive packaged with a circuit breaker and a bypass. The circuit breaker includes a door interlocked external operating handle. The operating handle can be padlocked in the OFF position (padlock not supplied). Enclosure options are UL (NEMA) Type 1, Type 12 and Type 3R.

The following is a typical power diagram.

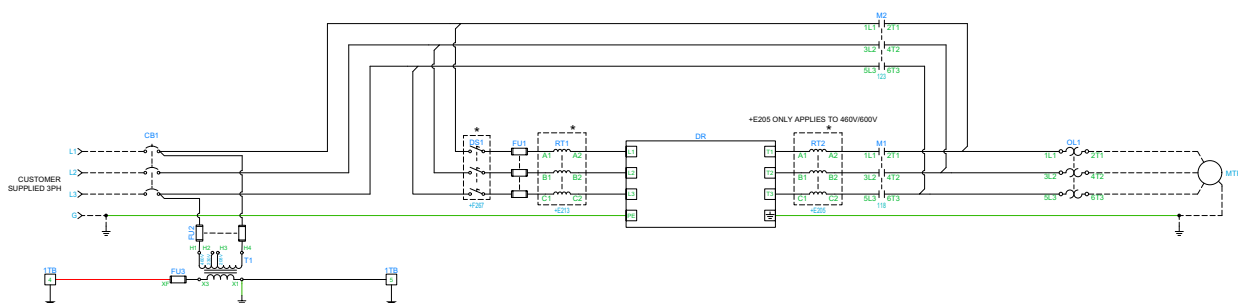

Figure 1 Power diagram with standard bimetallic motor overload

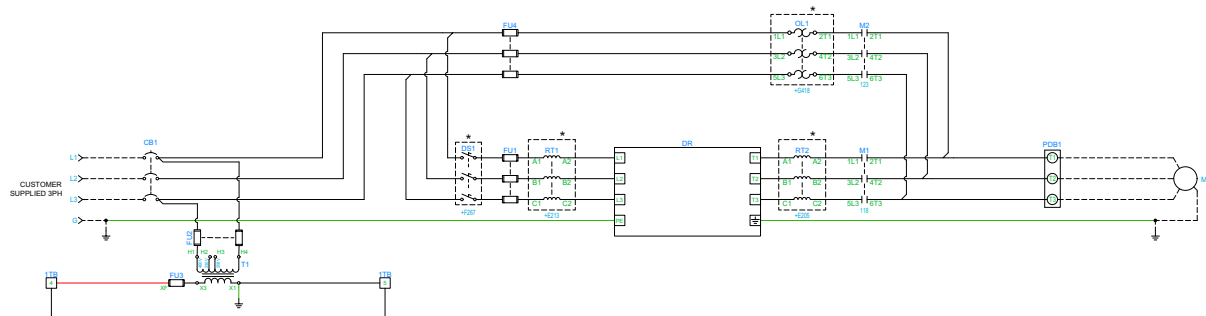

Figure 2 Power diagram with optional electronic motor overload (G418)

Item No.	Description	Option
CB1	Main circuit breaker	
T1	Control transformer	
DS1	Service Switch	F267
FU1	Drive fuses	
RT1	Drive input filter (line reactor)	E213
DR1	ACS580-01 base drive	
RT2	Drive output filter (dV/dt filter)	
M1	Motor contactor	
M2	Bypass contactor	
OL1	Motor overload relay	
PDB1	Power distribution block	with G418 only
FU4	Bypass fuses	with G418 only

Warning! The instructions below are for general operations. System operation varies by what options are included and how the drive parameters are set. See the electrical drawings for this specific system for detailed information about system operation.

Warning! Do NOT rotate the Manual/Off/Bypass switch while the motor is running. This could cause damage to the drive system. Always stop the motor by deenergizing the CR2 relay and Digital Input 6 (DI6). Then wait 10 seconds after the motor comes to a stop before changing the selection of this switch.

System Overview

The two-contactor bypass (G310) feature in the drive system is used to run the drive or bypass it for emergency operation of the motor. This is a manual bypass (except with option G311), requiring a person to switch to and from bypass. The system includes two electrically interlocked contactors, a motor overload relay and a door-mounted Drive/Off/Bypass switch. The switch has three settings (DRIVE, OFF, and BYPASS) and controls both contactors simultaneously. One contactor isolates line power from the motor when in DRIVE mode. The other contactor isolates the drive from the motor when in BYPASS mode.

Parameters

As shipped, the drive system uses the ABB Hand/Auto Macro with some parameter modifications:

Parameter No.	Parameter Name	Setting
20.11	Run Enable Stop Mode	1 = ramp
21.03	Stop Mode	1 = ramp

Additional modifications depend on which options are included:

All with SS2 Hand/Off/Auto selector switch (option P919):

Parameter No.	Parameter Name	Setting
19.17	Local Control Disable	1 = disabled
20.08	Ext2 In1 Source	2 = DI1

With SS2, without PT1 Speed potentiometer (option G303):

Parameter No.	Parameter Name	Setting
22.11	Ext1 Speed Ref1	18 = control panel (ref saved)
22.18	Ext2 Speed Ref1	1 = AI1 scaled
28.11	Ext1 Freq Ref1	18 = control panel (ref saved)

With SS2 and with PT1, above three parameters remain set to Hand/Auto macro settings.

IMPORTANT: See the “as shipped” drawing for specific settings for your drive.

The following description of operation assumes the above parameters are set as indicated.

Operation in Drive Mode

While the motor is stopped, move the Drive/Off/Bypass switch to the "drive" position. This engages the M1 contactor and sets the "run enable" input to the drive. This typically will not cause the motor to start turning.

Manual drive operation

1. To start the drive in manual mode, if the Hand/Off/Auto selector switch (SS2) option is included, move the switch (on the front of the cabinet) to the "Hand" position. This will start the motor. If the Hand/Off/Auto selector switch (SS2) option is not included, put the drive in "Local" mode using the drive control panel and start the drive using the control panel "Start" button.
2. Select manual speed using the "Up and Down" arrows on the drive control panel except when the Speed Potentiometer option is included. In that case, use the speed potentiometer to select manual speed.
3. To stop the drive in manual mode, if the Hand/Off/Auto selector switch (SS2) option is included, move the switch (on the front of the cabinet) to the "Off" position. This will stop the motor. If not included press the "Stop" button on the drive control panel.

Automatic operation

1. If the Hand/Off/Auto selector switch (SS2) option is included, move the switch (on the front of the cabinet) to the "Auto" position. If not included, put in "Remote" mode on the drive control panel.
2. To start the drive in auto mode, close dry contacts wired between terminals 1TB 9 and 10.
3. To select the speed in auto mode, if the Speed Potentiometer option is included, select auto speed by adjusting analog input 2 (AI2). If not included, select auto speed by adjusting analog input 1 (AI1).
4. To stop the drive in auto mode, open the circuit in step 2 above.

Operation in Bypass Mode

Manual operation

1. To start the motor in manual bypass when the Hand/Off/Auto selector switch (SS2) option is included:
 - a. While the motor is stopped, move Drive/Off/Bypass switch to the "Bypass" selection.
 - b. Move the Hand/Off/Auto selector switch (SS2) to the "Hand" position. This will start the motor across the line and run at 60hz.
2. To start the motor in manual bypass when the Hand/Off/Auto selector switch (SS2) option is NOT included:
 - a. While the motor is stopped, move Drive/Off/Bypass switch to the "Bypass" selection. This will start the motor across the line and run at 60hz.
3. To stop the motor in manual bypass, move the Hand/Off/Auto selector switch to "Off" (if present) or move the "Drive/Off/Bypass" to "Off."

Automatic operation (with Hand/Off/Auto switch only)

1. To start the motor in auto bypass, move the Hand/Off/Auto selector switch (SS2) switch to the "Auto" position. To start the motor, close dry contacts wired between terminals 1TB 9 and 10. This will start the motor across the line and run at 60hz.
2. Speed is not selectable in bypass mode. Motor will only run at full rated speed.
3. To stop the motor open the circuit in step 2 above.

Auto Transfer to Bypass Option

Some drive systems include the option for auto bypass as indicated by the presence of the characters "+G311" in the type code and the presence of switch SS3 inside the cabinet. This feature will allow the drive to automatically switch to bypass mode if the drive stops due to a fault. (A fault will be indicated on the control panel and relay output 3, RO3, will change from energized to deenergized.) When the fault is cleared, the system will switch out of bypass mode. Typically, the drive will not restart until a START command is received.

To enable auto bypass operation in the event of a fault, set switch SS3 (located inside the drive cabinet) to the ON position. The setting of this switch should only be changed when the motor and drive system are OFF and the circuit breaker disconnect is in the OFF position. If this is followed, changing SS3 to ON will not initiate motion of the motor.

Electronic and Bimetallic Overload

Some drive systems include a Type EF (EF370-380, for example) electronic motor overload relay. This device is only used during bypass operation. The electronic overload relay allows the user to select an overload class, either class 10, class 20 or class 30. For drives that require high starting torque, class 20 is recommended. Otherwise, class 10 is suitable.

Electronic overload relays are included when characters "+G418" are shown in the type code and on all drives with frame size R8 or R9.

All other drives include the Type TF (e.g. TF42-7.6) or TA (e.g. TA200DU150) bimetallic motor overload relay. This is a class 10 relay; the class rating is not adjustable.

Both types of overload relays are three pole relays with thermal tripping sensors. They are manually or automatically resettable. The device is manually reset by pushing the blue button on the relay. Manually resetting the relay requires turning the circuit breaker off and opening the cabinet door to access the relay. In auto reset, after the motor overload cools, it will reset, its fault contact will close allowing the motor to restart in bypass automatically. For additional information, go to library.abb.com and search for the first few characters of your relay (e.g. TA42, TF200DU or EF370) followed by "instructions".

See the table in [Appendix A - Overload Relays](#) for a list of overload relays by drive type code.

Service Switch (+F267)

The optional service switch (option F267) will manually disconnect power on the input side of the drive but will not disconnect power to the bypass circuit. It is NOT necessary to open the service switch to enable the bypass. The service switch must be closed to enable the drive.

Surge suppressor (+F264, 3R only)

The optional surge protective devices are designed to safeguard electrical system from transitory surges and impulses such as those caused by lightning and operations on the electrical grid. This option includes the SPD2-480-3P0 surge protective device:

- Nominal Voltage: 460 Vac +/- 15%
- Voltage Protection Rating (VPR): 1.5 kV
- Nominal discharge current ($I_n @ 8/20 \mu s$): 20 kA
- Maximum discharge current ($I_{max} @ 8/20 \mu s$): 50 kA
- Reference standards: UL 1449 4th Ed, IEC 61643-11 2011, 2012

Cabinet heater (3R only)

All Type 3R drive systems include a 100-Watt heater and a thermostat in the cabinet. The heater is internally powered from the 120 Vac control power transformer. It prevents condensation from forming inside the cabinet. The heater is controlled with an internal thermostat that shuts it off when the cabinet reaches the selected temperature. The suggested temperature setting is 50 degrees F (10 degrees C).

Terminals for customer control Voltage (option +G305)

This option provides 200 VA of spare 120 Vac single-phase control power, fused and connected to a terminal strip inside the cabinet. Typically it used in combination with L512 (CHDI-01) I/O extension module to provide power for the 120 Vac digital inputs and outputs. (Requires field wiring between the CPT and the I/O extension module.) The customer control power is available from terminals 4 and 5 on terminal block 1TB.

Universal 3-phase Voltage monitor (option +G394)

This option continually measures the voltage of each of the three phases to provide protection for 3-phase motors and sensitive loads. It senses under and overvoltage, voltage imbalance, phase loss and phase reversal.

- Line Voltage: 200 to 480 Vac +/- 15%
- Undervoltage trip: 88 - 92% of adjusted line Voltage
- Reset Voltage: +2% of trip Voltage
- Voltage Unbalance Trip Point: Adjustable from 2 - 10%
- Temperature: -40° to 60°C / -40° to 85°C

Bypass Controls Option (+P919)

Option +P919 adds additional pilot lights and a switch, as follows:

- HAND/OFF/AUTO - selector switch: used to put the drive in manual (hand) mode, automatic (auto) mode, or to shut off the motor
- Drive - pilot light (green): lit when the drive is able to power the motor
- BYPASS - pilot light (yellow): lit when the drive is bypassed
- EXTERNAL/MOL FAULT - pilot light (red): lit when the main motor overload (MOL) relay has tripped (used for bypass mode only)

Dimensions and weights

ACS580-0P, packaged drive with circuit breaker disconnect and two-contactor bypass, UL (NEMA) Type 1

Dimension Reference	Height (H1)		Height (H1)		Width (W1)		Width (W2)		Depth (D)		Weight	
	in	mm	in	mm	in	mm	in	mm	in	mm	lb	kg
CX1-21	36.00	914	35.50	902	13.70	348	8.00	203	13.32	338	90	41
CX1-22	53.44	1357	52.44	1332	16.30	414	10.00	254	14.35	364	175	80
CX1-23	61.87	1571	60.88	1546	19.31	490	10.00	254	18.98	482	375	170
CX1-24	73.44	1865	61.38	1559	34.75	883	26.00	660	20.40	518	550	250
CX1-25	84.00	2134	n/a	n/a	36	914	n/a	n/a	23.3	592	950	432

H1 - Height
 H2 - Mounting Height
 W1 - Width
 W2 - Mounting Width

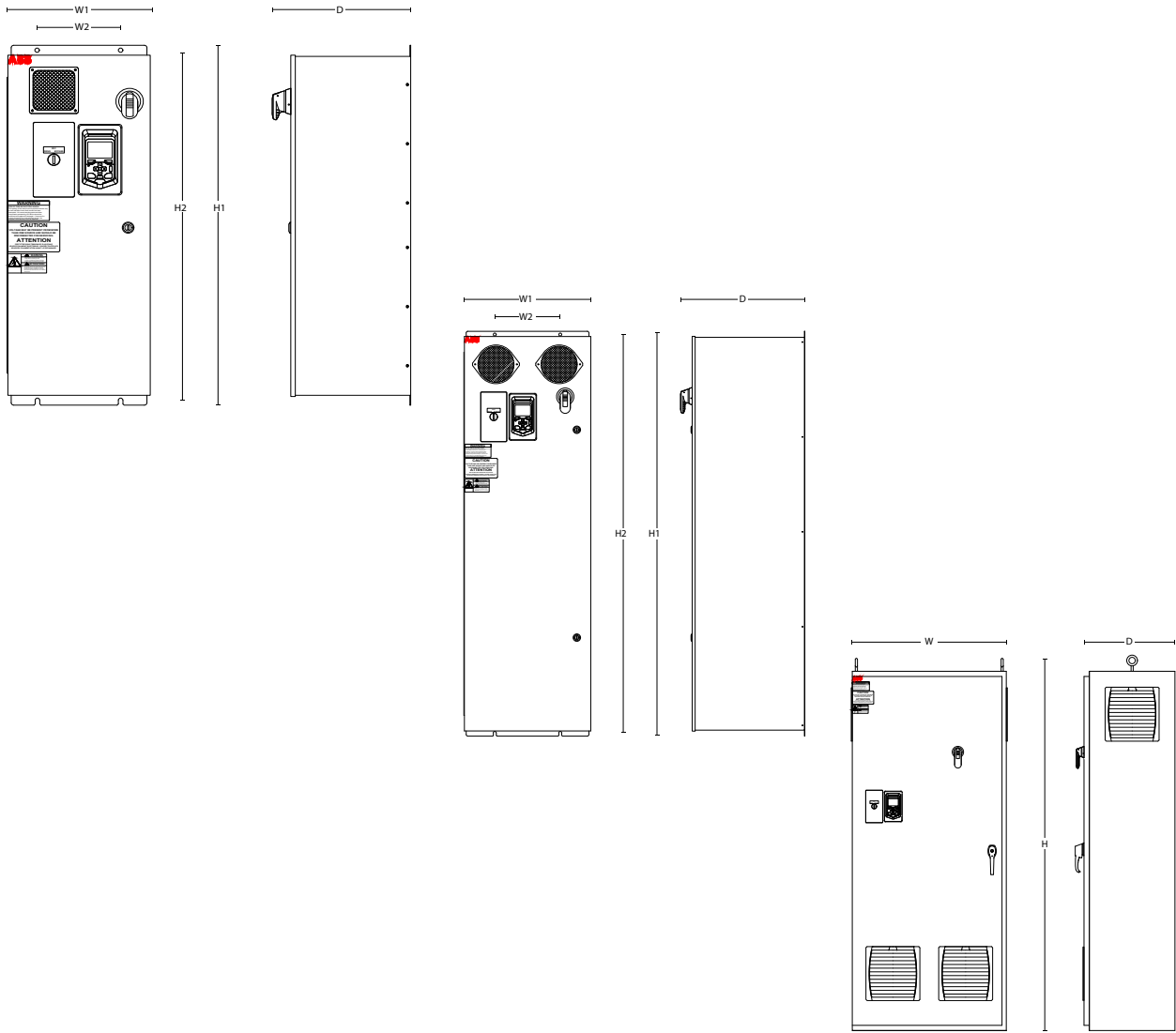

ACS580-0P, packaged drive with circuit breaker disconnect and two-contactor bypass, UL (NEMA) Type 12

Dimension Reference	Height (H1)		Height (H1)		Width (W1)		Width (W2)		Depth (D)		Weight	
	in	mm	in	mm	in	mm	in	mm	in	mm	lb	kg
CX12-21	24.00	610	22.50	572	18.00	457	16.50	419	15.00	381	85	39
CX12-22	30.00	762	28.50	724	24.00	610	22.50	572	15.00	381	155	70
CX12-23	36.00	914	34.50	876	30.00	762	28.50	724	15.00	381	207	94
CX12-24	48.00	1219	46.50	1181	36.00	914	34.50	876	21.00	533	410	186
CX12-25	72.00	1829	58.60	1488	36.00	914	34.50	876	20.90	531	608	276
CX12-26	84.00	2134	n/a	n/a	48.00	1219	n/a	n/a	23.30	592	950	432

H1 - Height
 H2 - Mounting Height
 W1 - Width
 W2 - Mounting Width

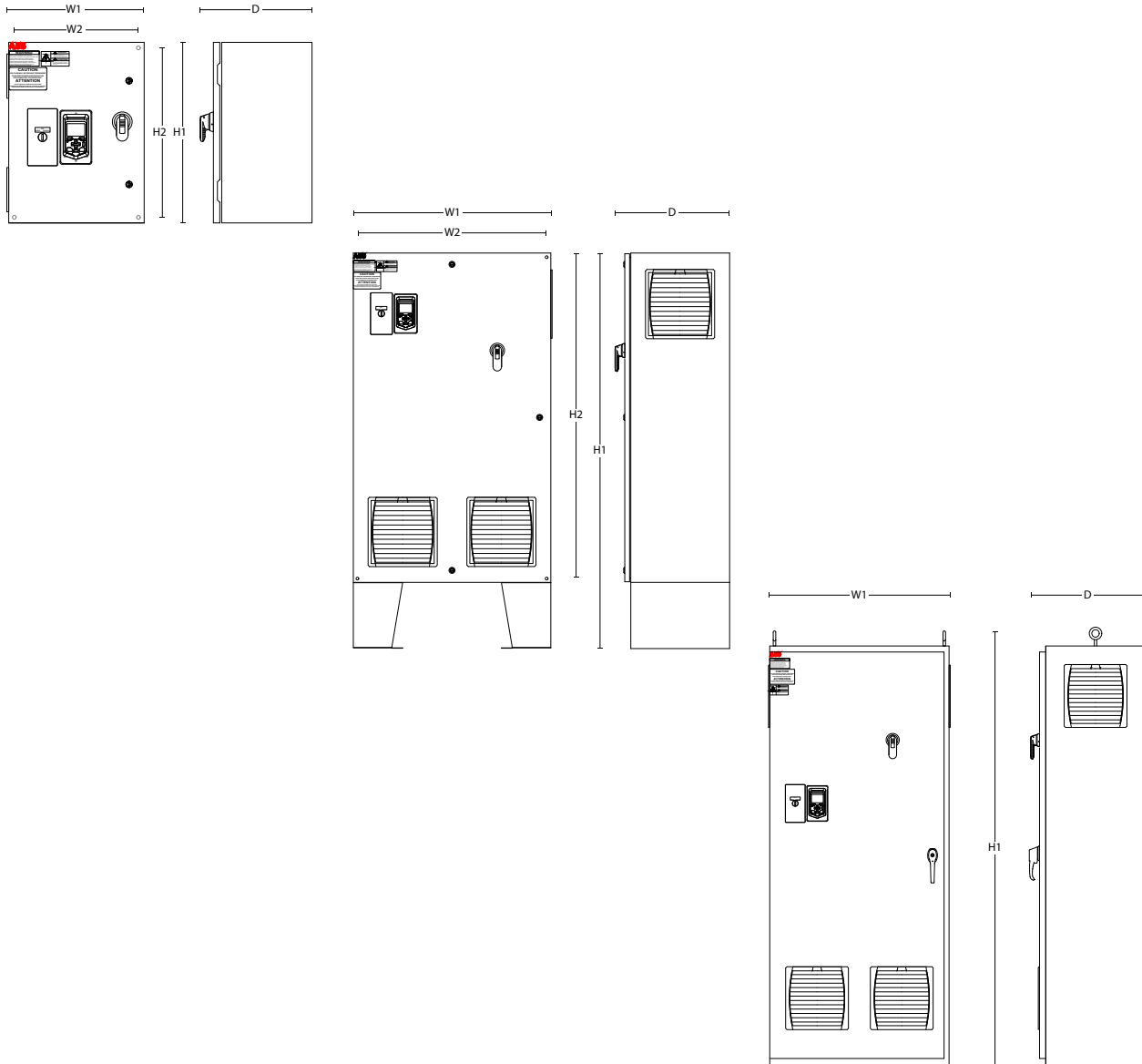

ACS580-0P, packaged drive with circuit breaker disconnect and two-contactor bypass, UL (NEMA) Type 3R

Dimension Reference	Height (H1)		Height (H1)		Width (W1)		Width (W2)		Depth (D)		Weight	
	in	mm	in	mm	in	mm	in	mm	in	mm	lb	kg
CX3R-21	27.34	694	22.50	572	18.21	463	16.50	419	14.38	365	90	41
CX3R-22	33.00	838	28.50	724	24.00	610	22.50	572	14.37	365	145	66
CX3R-23	39.40	1001	34.50	876	30.00	762	28.50	724	15.87	403	230	105
CX3R-24	51.00	1295	46.50	1181	36.00	914	34.50	876	20.37	517	445	202
CX3R-25	72.00	1829	58.60	1488	42.00	1067	34.50	876	25.10	638	675	307

H1 - Height
 H2 - Mounting Height
 W1 - Width
 W2 - Mounting Width

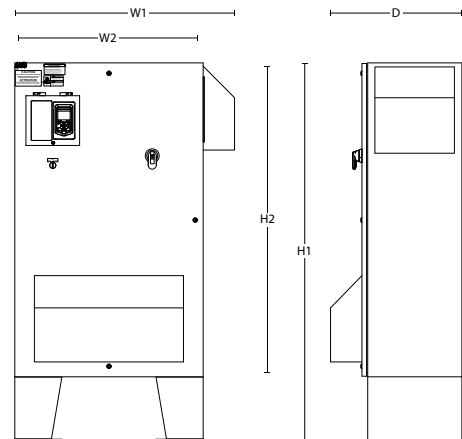
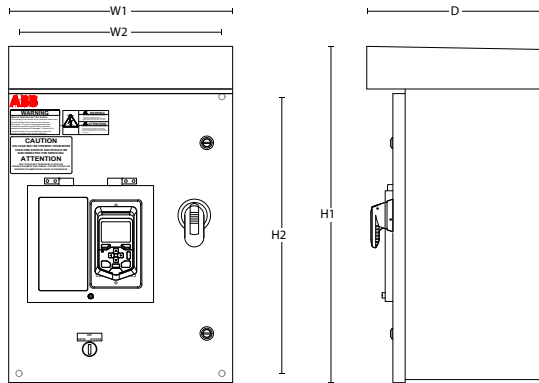

Appendix A - Overload Relays

208/230 Volt	Nominal output range		Base drive frame size	Standard overload	Optional overload (G418)
Type code	Drive current A	Package power HP		Model No.	Model No.
ACS580-0P-04A6-2+F255+G310	4.6	1	R1	TF42-5.7	EF19-6.3
ACS580-0P-06A6-2+F255+G310	6.6	1.5	R1	TF42-7.6	EF19-18.9
ACS580-0P-07A5-2+F255+G310	7.5	2	R1	TF42-7.6	EF19-18.9
ACS580-0P-10A6-2+F255+G310	10.6	3	R1	TF42-13	EF19-18.9
ACS580-0P-017A-2+F255+G310	16.7	5	R1	TF42-20	EF19-18.9
ACS580-0P-024A-2+F255+G310	24.2	7.5	R2	TF42-24	EF45-45
ACS580-0P-031A-2+F255+G310	30.8	10	R2	TF42-35	EF45-45
ACS580-0P-046A-2+F255+G310	46.2	15	R3	TF65-47	EF96-100
ACS580-0P-059A-2+F255+G310	59.4	20	R3	TF65-60	EF96-100
ACS580-0P-075A-2+F255+G310	74.8	25	R4	TF96-78	EF96-100
ACS580-0P-088A-2+F255+G310	88	30	R5	TF96-96	EF96-100
ACS580-0P-114A-2+F255+G310	114	40	R5	TF140DU-135	EF146-150
ACS580-0P-143A-2+F255+G310	143	50	R6	TA200DU150	EF205-210
ACS580-0P-169A-2+F255+G310	169	60	R7	TA200DU200	EF205-210
ACS580-0P-211A-2+F255+G310	211	75	R7	EF370-380	N/A
ACS580-0P-273A-2+F255+G310	273	100	R8	EF370-380	N/A

460 Volt	Nominal output range		Base drive frame size	Standard overload	Optional overload (G418)
Type code	Drive current A	Package power HP		Model No.	Model No.
ACS580-0P-02A1-4+F255+G310	2.1	1	R1	TF42-2.3	EF19-6.3
ACS580-0P-03A0-4+F255+G310	3	1.5	R1	TF42-3.1	EF19-6.3
ACS580-0P-03A5-4+F255+G310	3.5	2	R1	TF42-4.2	EF19-6.3
ACS580-0P-04A8-4+F255+G310	4.8	3	R1	TF42-5.7	EF19-6.3
ACS580-0P-07A6-4+F255+G310	7.6	5	R1	TF42-7.6	EF19-18.9
ACS580-0P-012A-4+F255+G310	12	7.5	R1	TF42-13	EF19-18.9
ACS580-0P-014A-4+F255+G310	14	10	R2	TF42-16	EF19-18.9
ACS580-0P-023A-4+F255+G310	23	15	R2	TF42-24	EF45-30
ACS580-0P-027A-4+F255+G310	27	20	R3	TF42-29	EF45-45
ACS580-0P-034A-4+F255+G310	34	25	R3	TF65-40	EF45-45
ACS580-0P-044A-4+F255+G310	44	30	R3	TF65-47	EF45-45
ACS580-0P-052A-4+F255+G310	52	40	R4	TF65-53	EF96-100
ACS580-0P-065A-4+F255+G310	65	50	R4	TF65-67	EF96-100
ACS580-0P-077A-4+F255+G310	77	60	R4	TF96-78	EF96-100
ACS580-0P-096A-4+F255+G310	96	75	R5	TF140DU-110	EF96-100
ACS580-0P-124A-4+F255+G310	124	100	R6	TF140DU-135	EF146-150
ACS580-0P-156A-4+F255+G310	156	125	R7	TA200DU175	EF205-210
ACS580-0P-180A-4+F255+G310	180	150	R7	TA200DU200	EF205-210

460 Volt	Nominal output range		Base drive frame size	Standard overload	Optional overload (G418)
Type code	Drive current	Package power			
	A	HP			
ACS580-0P-240A-4+F255+G310	240	200	R8	EF370-380	N/A
ACS580-0P-302A-4+F255+G310	302	250	R9	EF460-500	N/A
ACS580-0P-361A-4+F255+G310	361	300	R9	EF460-500	N/A
ACS580-0P-414A-4+F255+G310	414	350	R9	EF460-500	N/A

575 Volt	Nominal output range		Base drive frame size	Standard overload	Optional overload (G418)
Type code	Drive current	Package power			
	A	HP			
ACS580-0P-02A7-6+F255+G310	2.7	2	R2	TF42-3.1	EF19-6.3
ACS580-0P-03A9-6+F255+G310	3.9	3	R2	TF42-4.2	EF19-6.3
ACS580-0P-06A1-6+F255+G310	6.1	5	R2	TF42-7.6	EF19-6.3
ACS580-0P-09A0-6+F255+G310	9	7.5	R2	TF42-10	EF19-18.9
ACS580-0P-011A-6+F255+G310	11	10	R2	TF42-13	EF19-18.9
ACS580-0P-017A-6+F255+G310	17	15	R2	TF42-20	EF19-18.9
ACS580-0P-022A-6+F255+G310	22	20	R3	TF42-24	EF45-45
ACS580-0P-027A-6+F255+G310	27	25	R3	TF42-29	EF45-45
ACS580-0P-032A-6+F255+G310	32	30	R3	TF42-35	EF45-45
ACS580-0P-041A-6+F255+G310	41	40	R5	TF65-47	EF65-70
ACS580-0P-052A-6+F255+G310	52	50	R5	TF65-53	EF65-70
ACS580-0P-062A-6+F255+G310	62	60	R5	TF65-67	EF65-70
ACS580-0P-077A-6+F255+G310	77	75	R5	TF96-78	EF96-100
ACS580-0P-099A-6+F255+G310	99	100	R7	TF140DU-110	EF146-150
ACS580-0P-125A-6+F255+G310	125	125	R7	TF140DU-135	EF146-150
ACS580-0P-144A-6+F255+G310	144	150	R8	TA200DU175	EF205-210



3AXD50000780341 REVA
Effective: 08-03-2021
Supersedes:

ABB Inc.

16250 West Glendale Drive

New Berlin, WI 53151

USA

Telephone +1 800 752-0696

Fax +1 262 785-0397

Internet www.abb.com/drives